

INTRODUCTION TO GENETIC EPIDEMIOLOGY

(1012GENEP1)

Prof. Dr. Dr. K. Van Steen

DIFFERENT FACES OF GENETIC EPIDEMIOLOGY

1 Basic epidemiology

1.a Aims of epidemiology

1.b Designs in epidemiology

1.c An overview of measurements in epidemiology

2 Genetic epidemiology

2.a What is genetic epidemiology?

2.b Designs in genetic epidemiology

2.c Study types in genetic epidemiology

3 Phenotypic aggregation within families

3.a Introduction to familial aggregation?

3.b Familial aggregation with quantitative traits

IBD and kinship coefficient

3.c Familial aggregation with dichotomous traits

Relative recurrence risk

3.d Twin studies

4 Segregation analysis

4.a What is segregation analysis?

Modes of inheritance

4.b Classical method for sibships and one locus

Segregation ratios

4.c Likelihood method for pedigrees and one locus

Elston-Stewart algorithm

4.d Variance component modeling: a general framework

Decomposition of variability, major gene, polygenic and mixed models

4.e The ideas of variance component modeling adjusted for binary traits

Liability threshold models

5 Linkage and association

6 Genetic epidemiology and public health

1 Basic epidemiology

Main references:

- Burton P, Tobin M and Hopper J. Key concepts in genetic epidemiology. The Lancet, 2005
- Clayton D. Introduction to genetics (course slides Bristol 2003)
- Bonita R, Beaglehole R and Kjellström T. *Basic Epidemiology*. WHO 2nd edition
- URL:
 - <http://www.dorak.info/>

1.a Aims of epidemiology

- Epidemiology originates from Hippocrates' observation more than 2000 years ago that environmental factors influence the occurrence of disease. However, it was not until the nineteenth century that the distribution of disease in specific human population groups was measured to any large extent. This work marked not only the formal beginnings of epidemiology but also some of its most spectacular achievements.
- Epidemiology in its modern form is a relatively new discipline and uses quantitative methods to study diseases in human populations, to inform prevention and control efforts.

1.b Designs in epidemiology

- A focus of an epidemiological study is the population defined in geographical or other terms

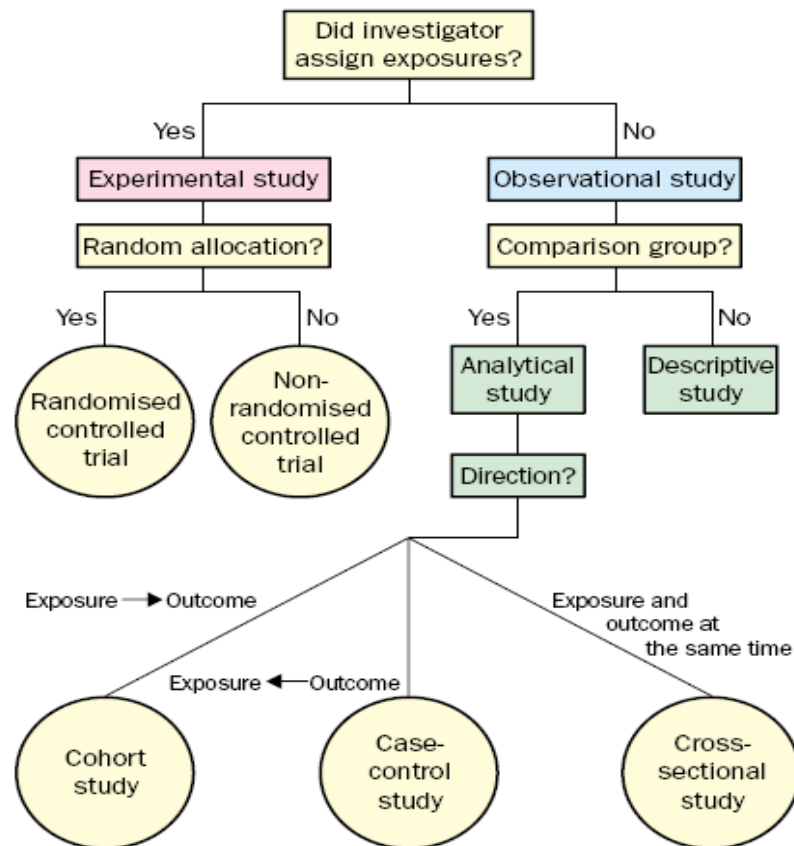

(Grimes & Schulz 2002)

1.c An overview of measurements in epidemiology

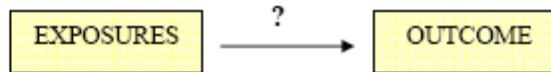

Epidemiology is about identifying associations between exposures and outcomes. To identify any association, exposures and outcomes must first be measured in a quantitative manner. Then rates of occurrence of events are computed. These measures are called “*measures of disease frequency*.” Once measured, the association between exposures and outcomes are then evaluated by calculating “*measures of association or effect*.” Finally, the impact of removal of an exposure on the outcome is evaluated by computing “*measures of potential impact*.” In general, measures of disease frequency are needed to generate measures of association, and both these are needed to get measures of impact. There is some overlap between these measures, and terminology is poorly standardized.

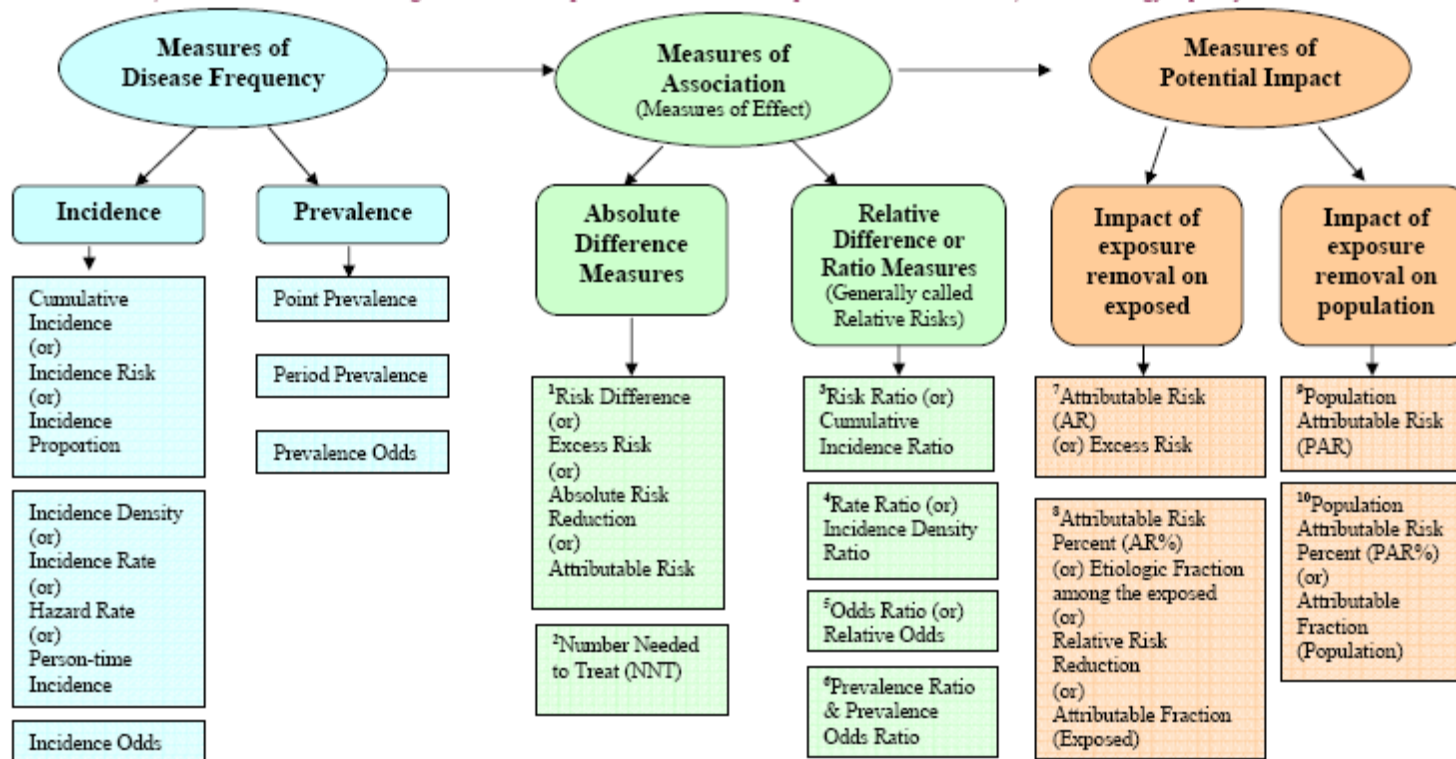

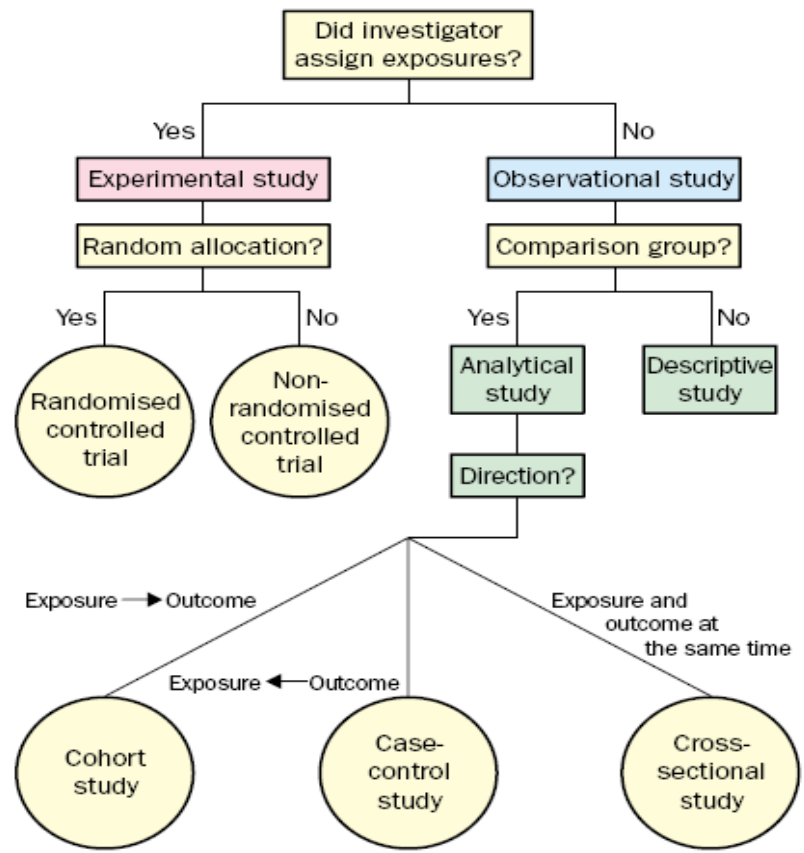

(Grimes and Schulz 2002)

Summary of most important features by design

	Cross-sectional study	Case-control study	Cohort study
Measure of disease frequency	Prevalence	Prevalence	Incidence
Direction of investigation	momentary/ Retrospective	Retrospective	Prospective
Samples (selections) involved	1 sample from the population	1 group of cases, 1 group of controls	1 cohort of exposed, 1 cohort of unexposed
Primary measure of association	Prevalence odds ratio	Odds ratio	Relative risk; attributable risk

Summary of major advantages (**bold**) and disadvantages

	Cross-sectional study	Case-control study	Cohort study
Marginal conditions	quick relatively cheap	quick relatively cheap	time-consuming relatively costly
Applicability	permanent risk factors quite common dis.	more general rare diseases	more general
Data quality	as good as diagnosis	errors in historic data	as good as diagnosis
Sample sizes	large (low prevalences)	relatively small	large (dropout, low inc.)
Inferences/ estimatability	no causal evidence no incidence prev. of exposure prev. of disease	limited causal evidence no incidence prev. of exposure no prev. of disease	causal evidence incidence no prev. of exposure prev. of disease

2 Genetic epidemiology

Main references:

- Clayton D. Introduction to genetics (course slides Bristol 2003)
- Ziegler A. Genetic epidemiology present and future (presentation slides)
- URL:
 - <http://www.dorak.info/>
 - <http://www.answers.com/topic/>
 - http://www.arbo-zoo.net/_data/ArboConFlu_StudyDesign.pdf

2.a What is genetic epidemiology?



**INTERNATIONAL GENETIC
EPIDEMIOLOGY SOCIETY**

Contact Us: iges@geneticepi.org



Home
About IGES
Scientific Meetings
Publications
Organization
Membership
Position Openings
Latest News
Login
Abstracts

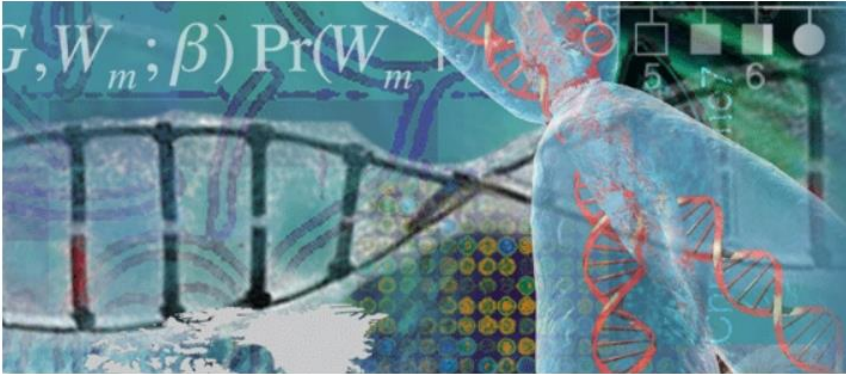

International Genetic Epidemiology Society

IGES is the International Genetic Epidemiology Society, a scientific society concerned with the study of genetic components in complex biological phenomena.

Welcome!

Upcoming Events

The **23rd Annual IGES Meeting** will be held in Vienna, Austria, **August 28-30, 2014**. The meeting will be held in conjunction with two other major international scientific events – the *35th Annual Conference of the International Society for Clinical Biostatistics* and the *Genetic Analysis Workshop 19*. Details [here](#).



The **35th Annual Conference of the International Society for Clinical Biostatistics** will be held in Vienna, Austria, **August 24-28, 2014**. Details on the scientific topics of the conference, the invited sessions, the conference courses, and on the mini-symposia on Thursday morning are available on this [website](#).



Not an IGES Member? Sign up!

Online registration for IGES

Follow us!





Statistical Genetics

- Genetic epidemiology is closely allied to both molecular epidemiology and **statistical genetics**, but these overlapping fields each have distinct emphases, societies and journals.
- Statistical geneticists are highly trained scientific investigators who are specialists in both statistics and genetics: Statistical geneticists must be able to understand molecular and clinical genetics, as well as mathematics and statistics, to effectively communicate with scientists from these disciplines.
- Statistical genetics is a very exciting professional area because it is so new and there is so much demand. It is a rapidly changing field, and there are many fascinating scientific questions that need to be addressed.
Additionally, given the interdisciplinary nature of statistical genetics, there are plenty of opportunities to interact with researchers and clinicians in other fields, such as epidemiology, biochemistry, physiology, pathology, evolutionary biology, and anthropology.

True or False?

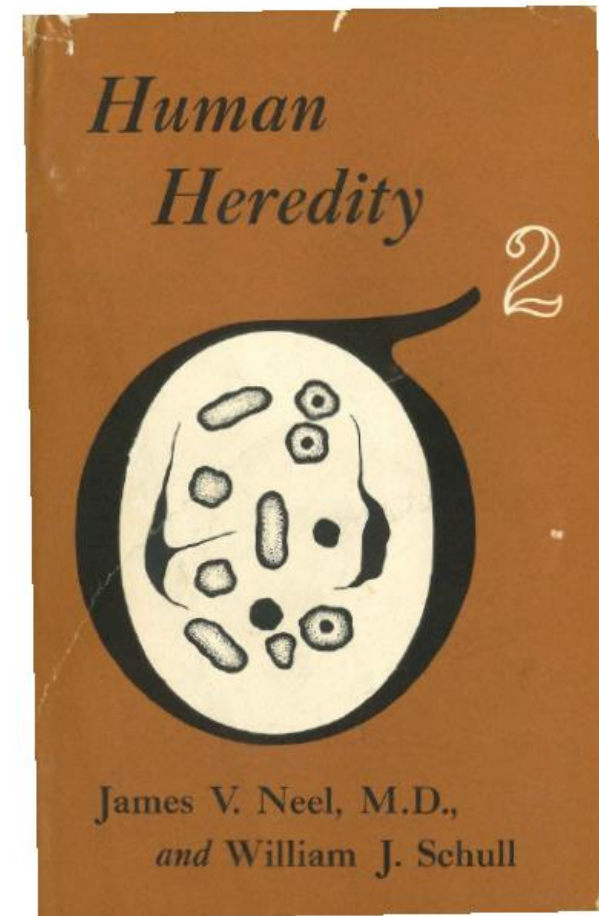
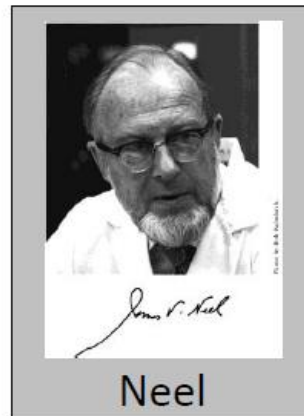
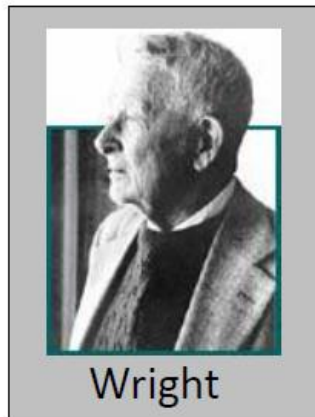
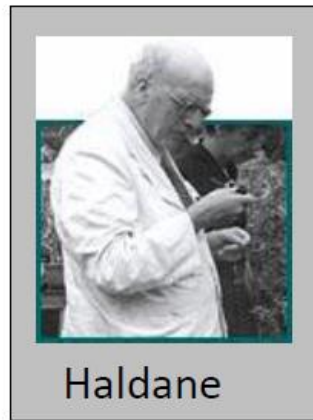
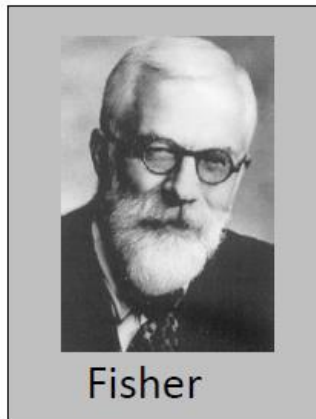
- A primary **difference between statistical genetics and genetic epidemiology** is that statistical geneticists are often more interested in the development and evaluation of new statistical methods, whereas genetic epidemiologists focus more on the application of statistical methods to biomedical research problems.
- A primary **difference between genetic and molecular epidemiology** is that the first is also concerned with the detection of inheritance patterns.



Founders of Statistical Genetics

(IGES presidential address A Ziegler, Chicago 2013)

Towards a definition for genetic epidemiology ...

No agreement

Khoury, Beaty, Cohen: Researchers have still not fully agreed on the definition and the scope of genetic epidemiology.



(IGES presidential address A Ziegler, Chicago 2013)

Towards a definition for genetic epidemiology ...

interaction between “genetic” and “epi” (1984)?

Rao: Genetic epidemiology ... represents an important interaction between the two parent disciplines: genetics and epidemiology. ...

- ◆ [It] **differs from epidemiology** by its explicit consideration of genetic factors and family resemblance
- ◆ It **differs from population genetics** by its focus on disease
- ◆ It ... **differs from medical genetics** by its emphasis on population aspects

(IGES presidential address A Ziegler, Chicago 2013)

Towards a definition for genetic epidemiology ...

via the process of defining genetic basis (1086, 2004)?

Thomas: ... The process of defining the genetic basis of a disease usually follows a progression such as the [following] ...

- ◆ Descriptive epidemiology
- ◆ Familial aggregation
- ◆ Segregation analysis
- ◆ Linkage analysis
- ◆ Fine mapping
- ◆ Association
- ◆ Cloning
- ◆ Characterization

(IGES presidential address A Ziegler, Chicago 2013)

Towards a definition for genetic epidemiology ...

- Term firstly used by Morton & Chung (1978)
- Genetic epidemiology examines the role of genetic factors, along with the environmental contributors to disease, and at the same time giving equal attention to the differential impact of environmental agents, non-familial as well as familial, on different genetic backgrounds (Cohen, Am J Epidemiol, 1980)
- Genetic epidemiology is the study of how and why diseases cluster in families and ethnic groups (King et al., 1984)
- Genetic epidemiology is a science which deals with the etiology, distribution, and control of disease in groups of relatives and with inherited causes of disease in populations . (Morton & Chung, 1978 --> 1995).

Aim of genetic epidemiology

to detect the inheritance pattern of a particular disease,
to localize the gene and
to find a marker associated with disease susceptibility



(Photo: J. Murken via A Ziegler)

Use of genetic terms over time

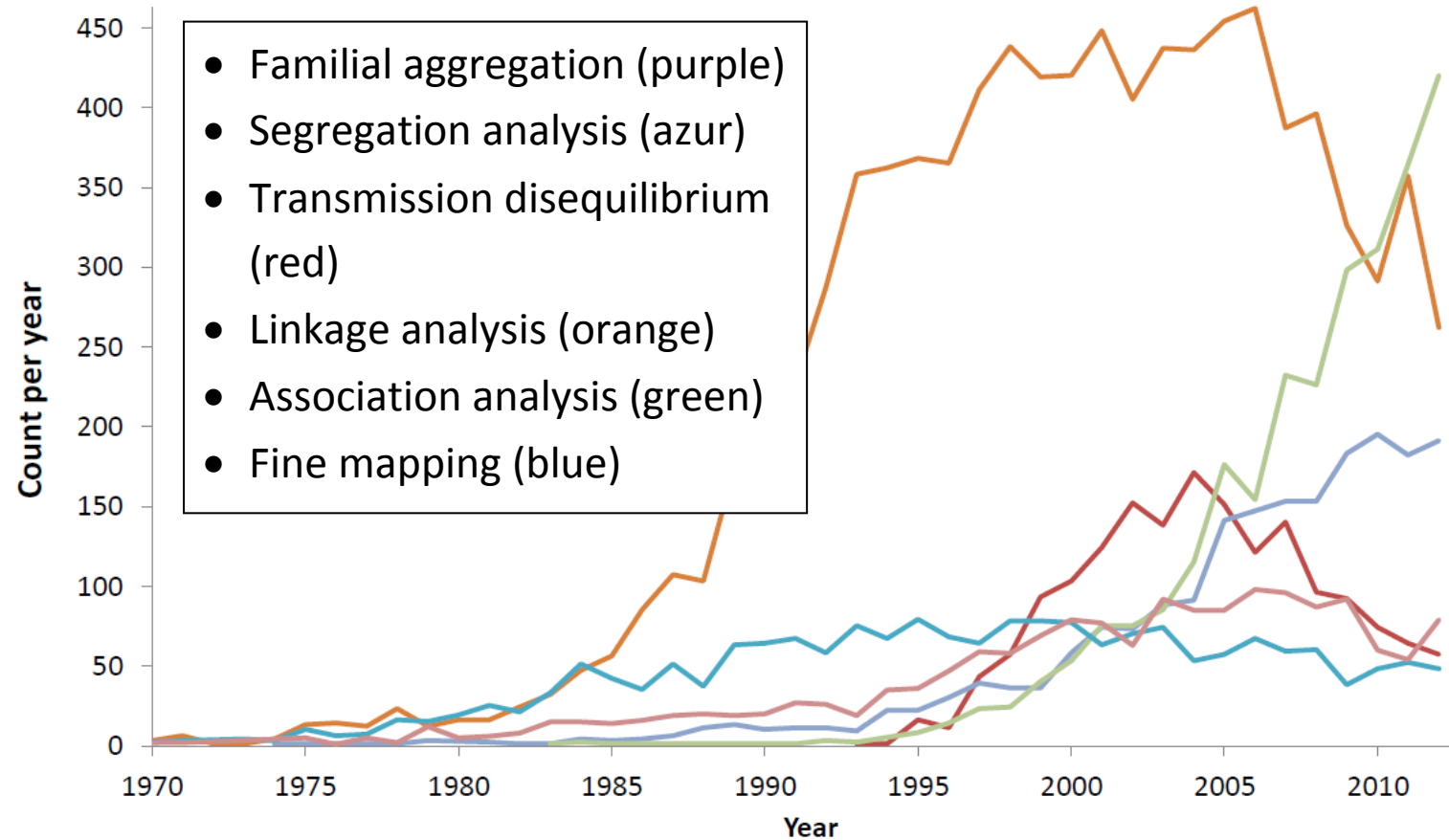

(adapted from IGES presidential address A Ziegler, Chicago 2013)

X-epidemiology

- The phrase "molecular epidemiology" was first coined in 1973 by Kilbourne in an article entitled "The molecular epidemiology of influenza".
- The term became more formalized with the formulation of the first book on "Molecular Epidemiology: Principles and Practice" by Schulte and Perera.
- Nowadays, molecular epidemiologic studies measure exposure to specific substances (DNA adducts) and early biological response (somatic mutations), evaluate host characteristics (genotype and phenotype) mediating response to external agents, and use markers of a specific effect (like gene expression) to refine disease categories (such as heterogeneity, etiology and prognosis).

X – epidemiology

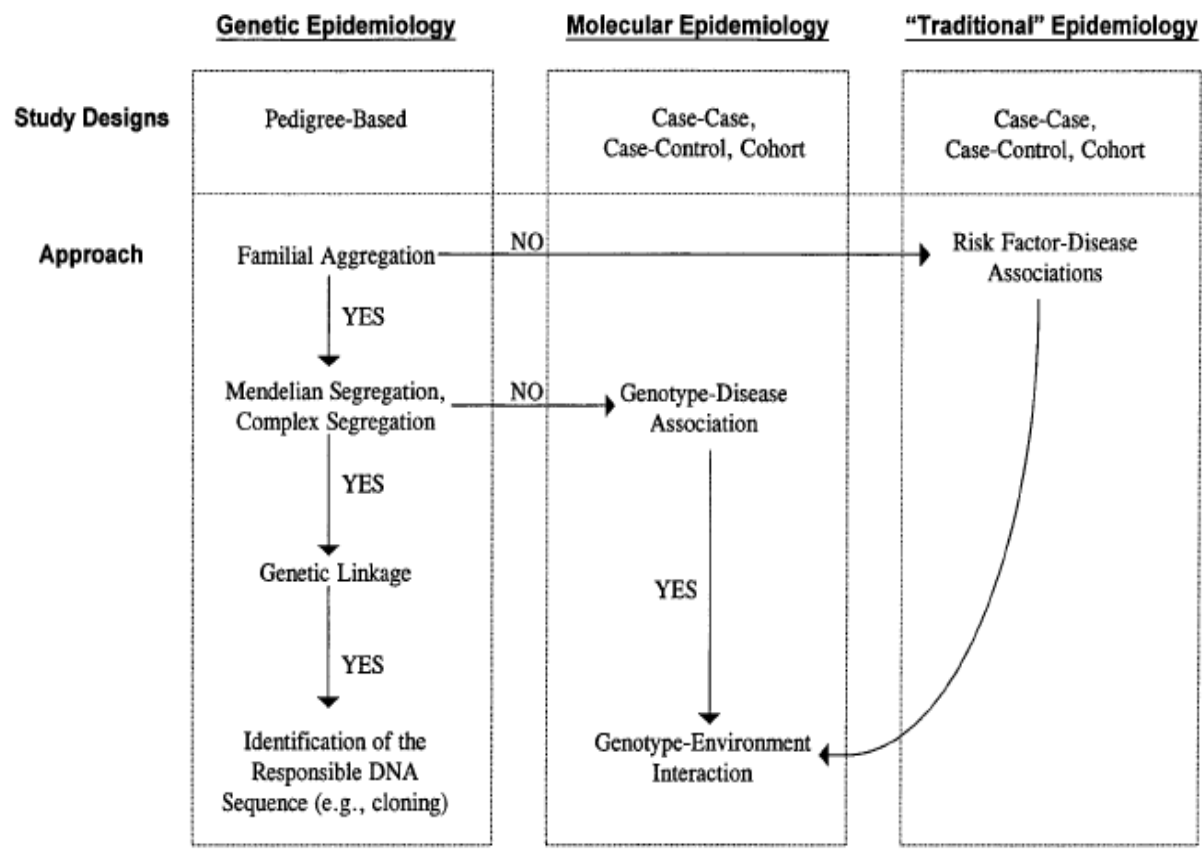

(Rebbeck TR, *Cancer*, 1999)

New kids around the block

The field of public health genomics (Khoury 2010)

Khoury et al.: Public health genomics, a multidisciplinary field concerned with the **effective and responsible translation of genome-based knowledge and technologies to improve population health**. ... Public health genomics uses population-based data on genetic variation and gene-environment interactions to develop, implement, and evaluate evidence-based tools for improving health and preventing disease

(IGES presidential address A Ziegler, Chicago 2013)

Towards a definition for genetic epidemiology ...

A science that deals with the **etiology, distribution and control of disease-related phenotypes** in groups of **relatives**, and with **inherited causes of disease-related phenotypes in populations**

+

Statistical methodology
Genome-wide association studies
Next generation sequencing
Gene-environment interaction
Family studies
Risk score
Predictive markers & pharmacogenetics
Microbiome
Epigenetics
eQTL
Other Omics

(IGES presidential address A Ziegler, Chicago 2013)

The genetic epidemiology context

- In contrast to classic epidemiology, the three main complications in **modern** genetic epidemiology are
 - dependencies,
 - use of indirect evidence and
 - complex data sets
- Genetic epidemiology is highly dependent on the direct incorporation of family structure and biology. The structure of families and chromosomes leads to major dependencies between the data and thus to customized models and tests. In many studies only indirect evidence can be used, since the disease-related gene, or more precisely the functionally relevant DNA variant of a gene, is not directly observable. In addition, the data sets to be analyzed can be very complex.

Key concepts in genetic epidemiology

Genetic Epidemiology 1

Key concepts in genetic epidemiology

Paul R Burton, Martin D Tobin, John L Hopper

This article is the first in a series of seven that will provide an overview of central concepts and topical issues in modern genetic epidemiology. In this article, we provide an overall framework for investigating the role of familial factors, especially genetic determinants, in the causation of complex diseases such as diabetes. The discrete steps of the framework to be outlined integrate the biological science underlying modern genetics and the population science underpinning mainstream epidemiology. In keeping with the broad readership of *The Lancet* and the diverse background of today's genetic epidemiologists, we provide introductory sections to equip readers with basic concepts and vocabulary. We anticipate that, depending on their professional background and specialist knowledge, some readers will wish to skip some of this article.

What is genetic epidemiology?

Epidemiology is usually defined as “the study of the distribution, determinants [and control] of health-related states and events in populations”.¹ By contrast, genetic epidemiology means different things to different people.²⁻⁷ We regard it as a discipline closely allied to traditional epidemiology that focuses on the familial, and in particular genetic, determinants of disease and the joint effects of genes and non-genetic determinants. Crucially, appropriate account is taken of the biology that underlies the action of genes and the

close. The marker and the causative variant need not be within the same gene. This principle is the basis of genetic linkage analysis (see a later paper in this series¹²), which has achieved many of the breakthroughs in the genetics of disease causation. Many such breakthroughs involve conditions caused by variants in a single gene and have been achieved by geneticists and clinical geneticists who would not view themselves as genetic epidemiologists. Nevertheless, linkage analysis is one of the most important tools available to the genetic epidemiologist.

Lancet 2005; 366: 941–51

See Comment page 880

This is the first in a Series of seven papers on genetic epidemiology.

Department of Health Sciences and Department of Genetics, University of Leicester, Leicester, UK

(Prof P R Burton MD, M D Tobin PhD); and Centre for Genetic Epidemiology, University of Melbourne, Melbourne, Victoria, Australia (Prof J L Hopper PhD)

Correspondence to: Prof Paul R Burton, Department of Health Sciences, University of Leicester, 22–28 Princess Road West, Leicester LE1 6TP, UK
pb51@le.ac.uk

Relevant questions in genetic epidemiology

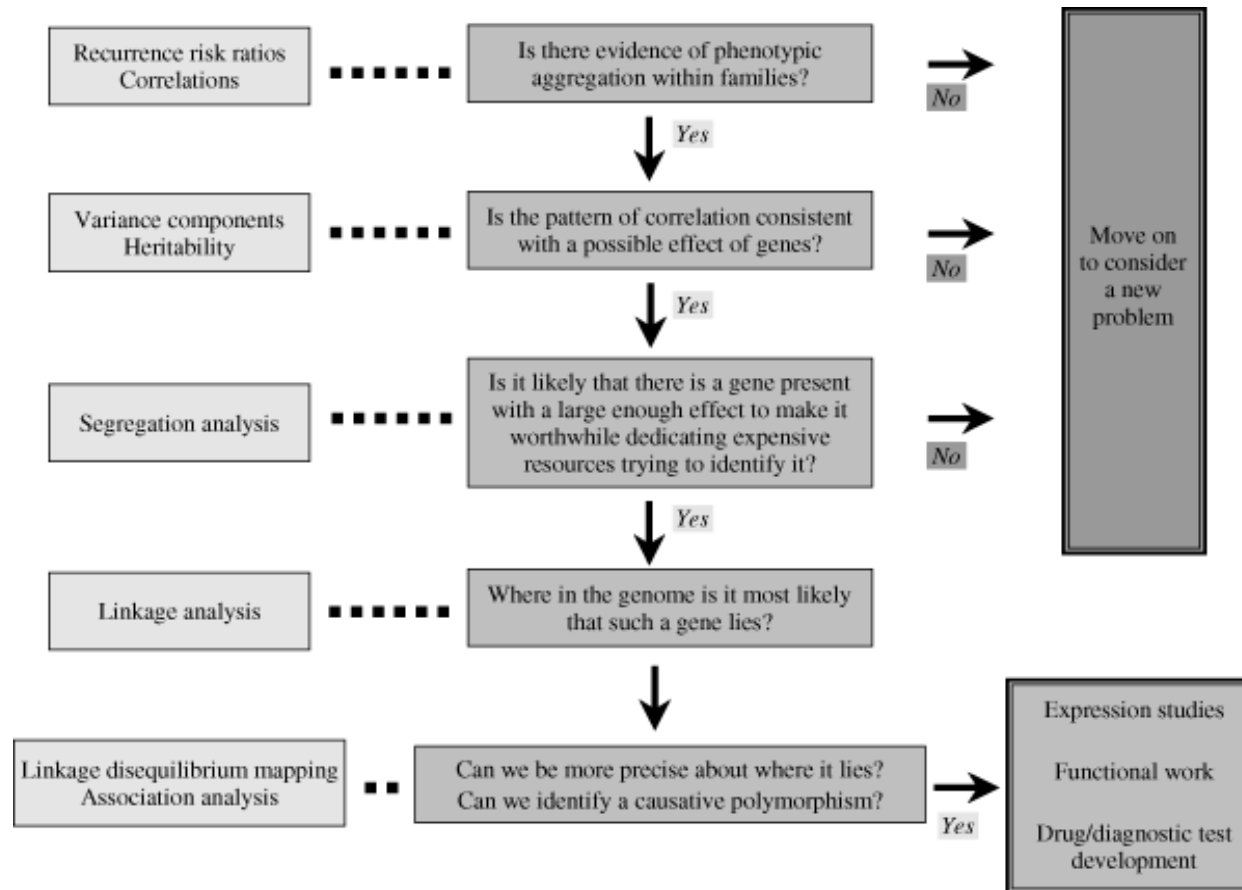

(Handbook of Statistical Genetics - John Wiley & Sons; Fig.28-1)

Flow of research in genetic epidemiology

Disease characteristics:	Descriptive epidemiology
Familial clustering:	Family aggregation studies
Genetic or environmental:	Twin/adoption/half-sibling/migrant studies
Mode of inheritance:	Segregation analysis
Disease susceptibility loci:	Linkage analysis
Disease susceptibility markers:	Association studies

<http://www.dorak.info/epi/genetepi.html>

Genetic research paradigm

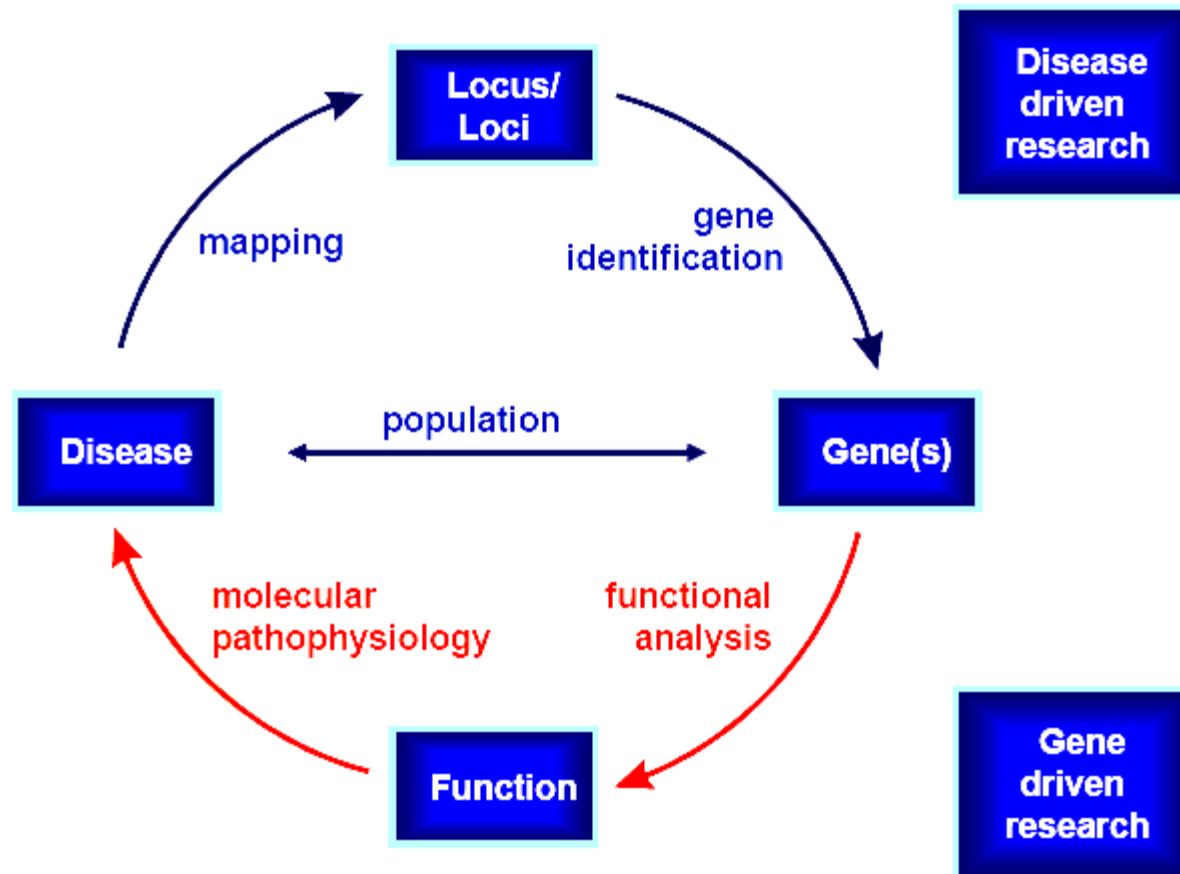

Migration studies: an unexpected role in genetic epidemiology?

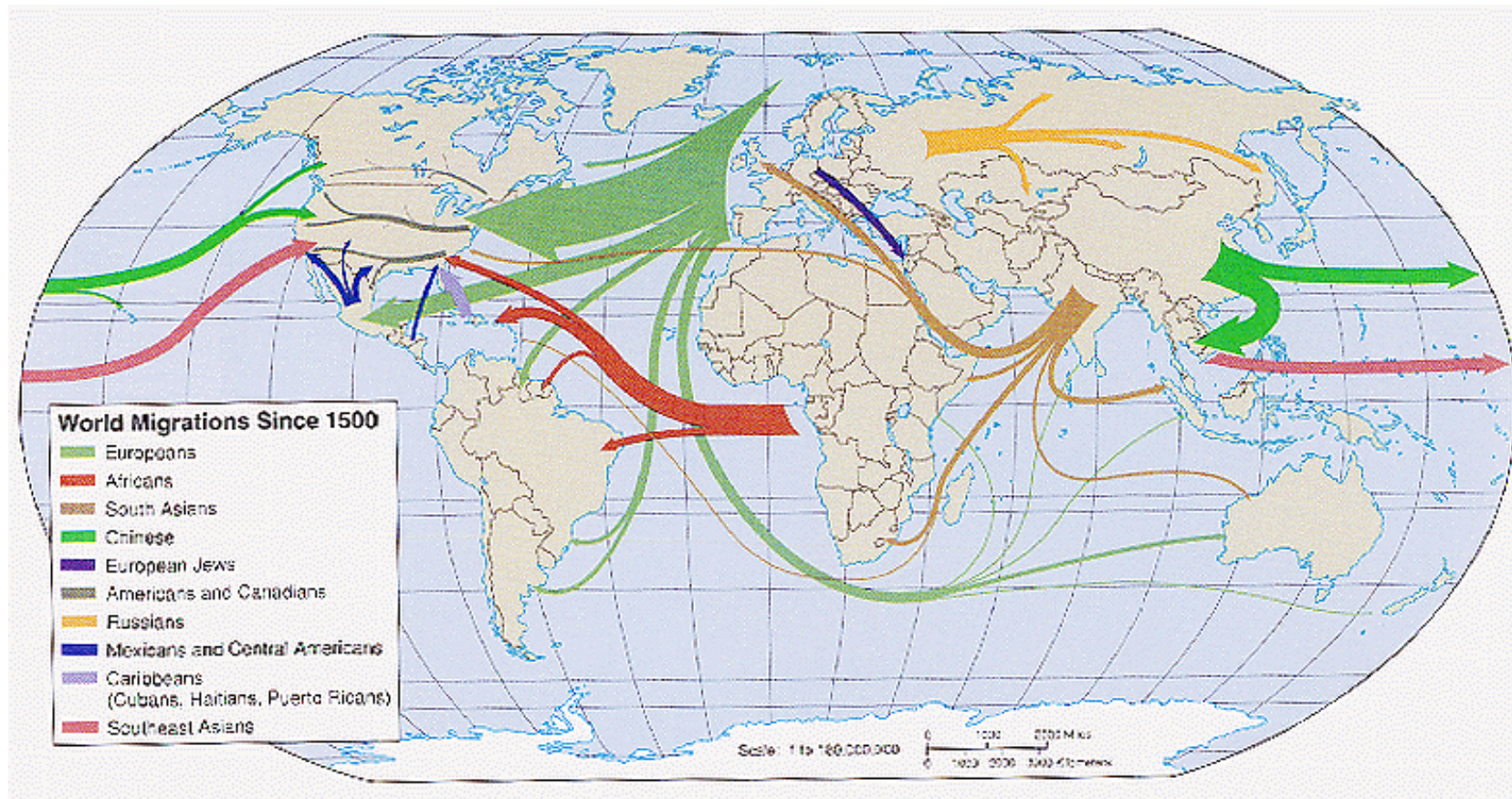

(Weeks, Population. 1999)

Migration studies

- As one of the initial steps in the process of genetic epidemiology, one could use information on populations who migrate to countries with different genetic and environmental backgrounds - as well as rates of the disease of interest - than the country they came from.
- Here, one compares people who migrate from one country to another with people in the two countries.
- If the migrants' disease frequency does not change –i.e., remains similar to that of their original country, not their new country—then the disease might have genetic components.
- If the migrants' disease frequency does change—i.e., is no longer similar to that of their original country, but now is similar to their new country—then the disease might have environmental components

Linkage and Association

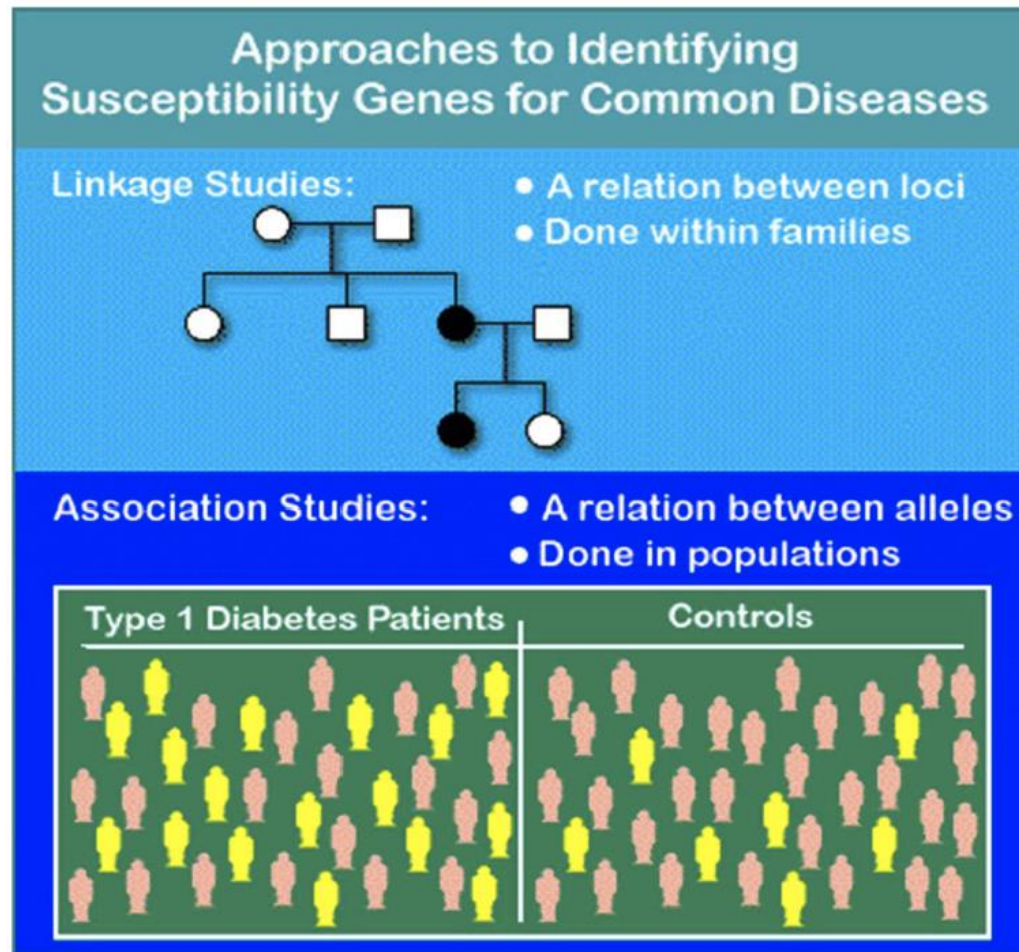

(Roche Genetics Education)

Scaling up to “genome-wide” levels ...

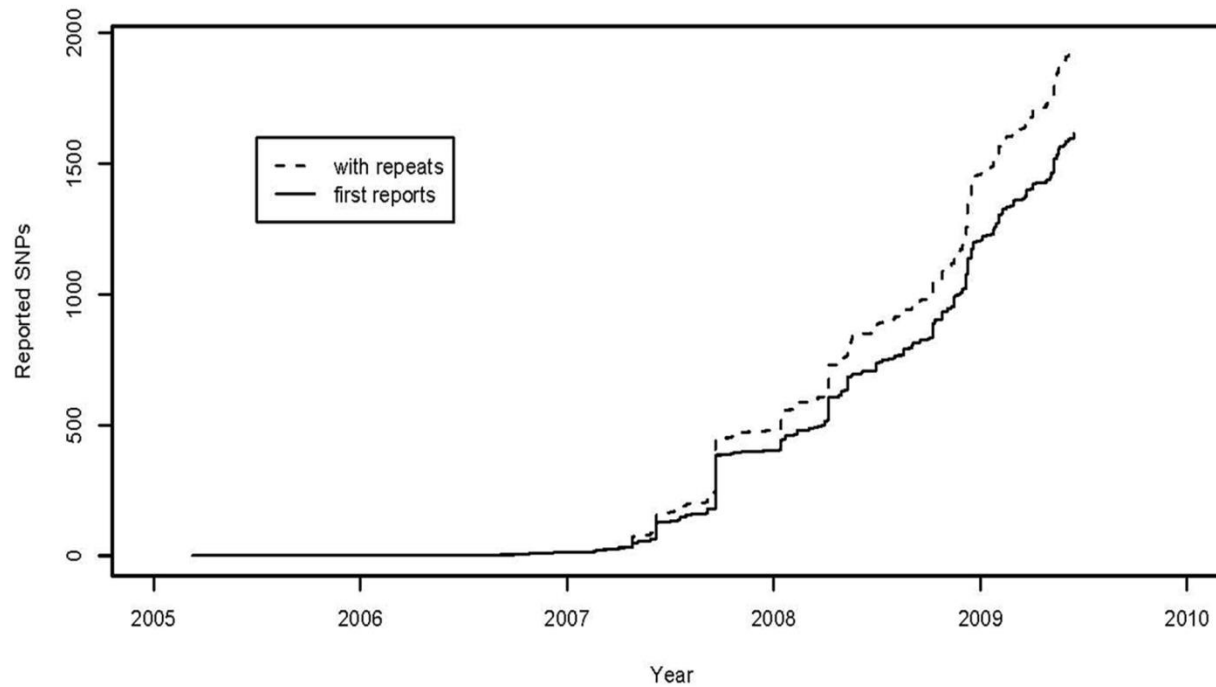
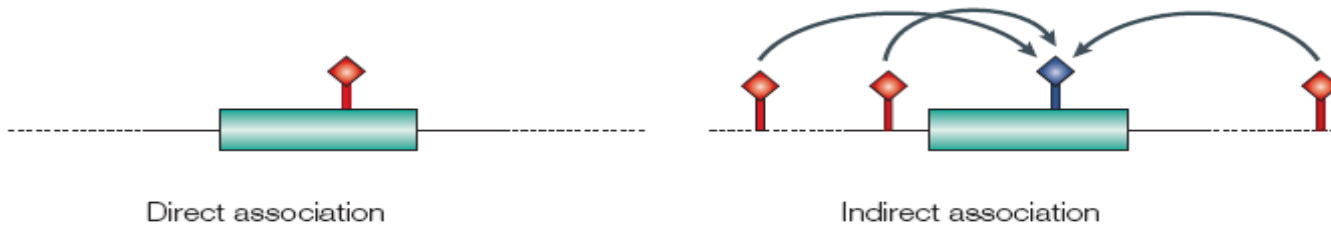

Top: Hirschhorn & Daly, Nat Rev Genet 2005; Bottom: Witte An Rev Pub Health 2009

Getting closer to the whole picture

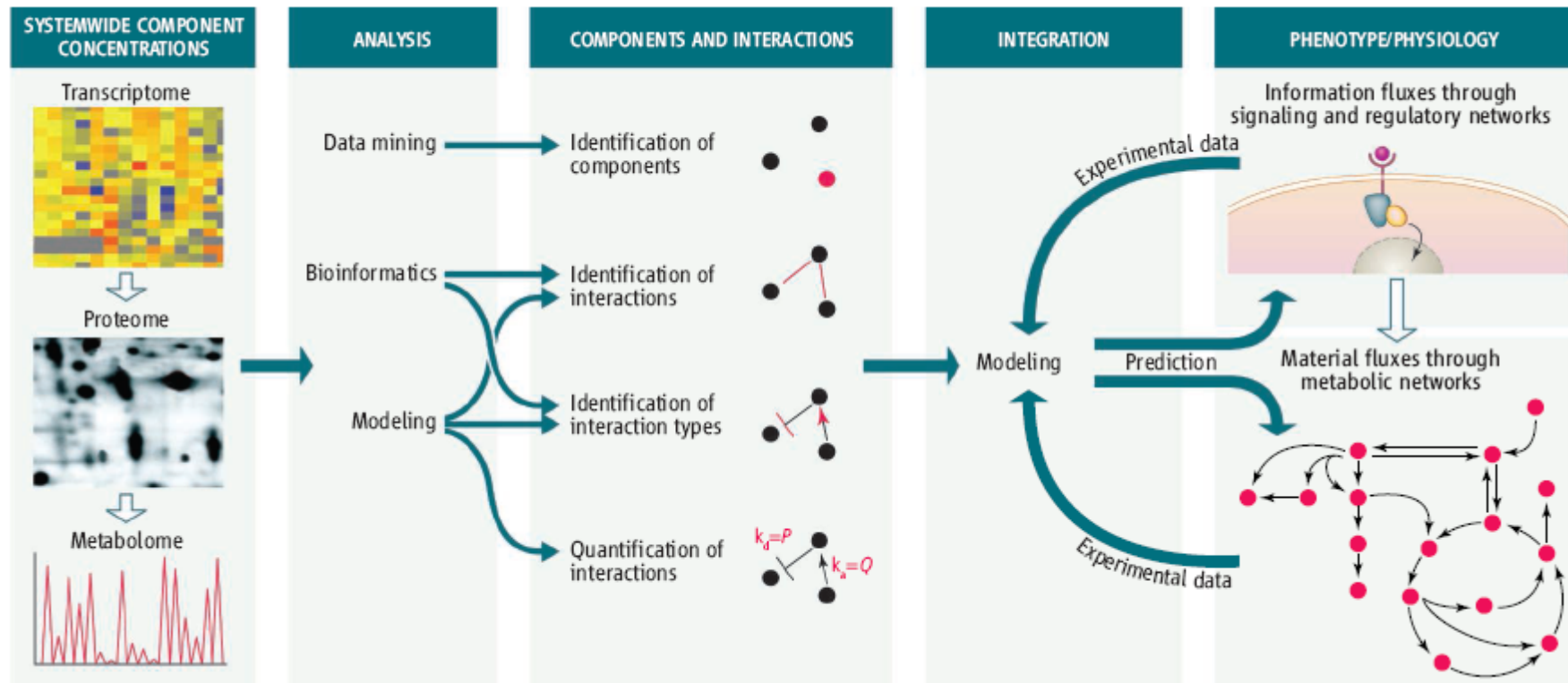

(Sauer et al, *Science*, 2007)

Genetic testing based on GWA studies

- Multiple companies marketing direct to consumer genetic ‘test’ kits.
- Send in spit.
- Array technology (Illumina / Affymetrix).
- Many results based on GWAS.
- Companies:



- Navigenics

The screenshot shows the 23andMe website interface. At the top left is the 23andMe logo. To the right are buttons for 'sign in', 'register kit', and a shopping cart icon with '0' items. Below the logo is a navigation bar with links for 'welcome', 'ancestry', 'health', 'how it works' (highlighted), 'store', 'search', and 'help'. On the left side, there is a vertical menu with 'Order', 'Register', 'Spit', 'Send', and 'Discover' (highlighted with a white arrow). The main content area features a promotional banner for 'finding your roots with HENRY LOUIS GATES, JR.' The banner includes an 'Ancestry Painting' chart showing: European 60%, African 34%, and Asian 6%. Below the chart, there are two sections: 'Ancestry' with sub-points 'Relative Finder', 'Global Origins', and 'Ancestral Lineages'; and 'Health' with sub-points 'Carrier Status', 'Disease Risk', and 'Drug Response'. To the right of the banner is a smartphone displaying the 23andMe app interface with a 'Results' screen showing categories like 'New & Updated' (56), 'Disease Risk' (30), 'Carrier Status' (44), 'Traits' (13), and 'Drug Response' (8). At the bottom of the banner is a grey bar with the text 'Start exploring your DNA...' and a red 'Add to Cart' button.

Janssens and van Duijn *Investigative Genetics* 2010, 1:10
<http://www.investigativegenetics.com/content/1/1/10>

**OPINION****Open Access**

An epidemiological perspective on the future of direct-to-consumer personal genome testing

A Cecile JW Janssens*, Cornelia M van Duijn

Abstract

Personal genome testing is offered via the internet directly to consumers. Most tests that are currently offered use data from genome-wide scans to predict risks for multiple common diseases and traits. The utility of these tests is limited, predominantly because they lack predictive ability and clear benefits for disease prevention that are specific for genetic risk groups. In the near future, personal genome tests will likely be based on whole genome sequencing, but will these technological advances increase the utility of personal genome testing? Whole genome sequencing theoretically provides information about the risks of both monogenic and complex diseases, but the practical utility remains to be demonstrated. The utility of testing depends on the predictive ability of the test, the likelihood of actionable test results, and the options available for the reduction of risks. For monogenic diseases, the likelihood of known mutations will be extremely low in the general population and it will be a challenge to recognize new causal variants among all rare variants that are found using sequencing. For complex diseases, the predictive ability of genetic tests will be mainly restricted by the heritability of the disease, but also by the genetic complexity of the disease etiology, which determines the extent to which the heritability can be understood. Given that numerous genetic and non-genetic risk factors interact in the causation of complex diseases, the predictive ability of genetic models will likely remain modest. Personal genome testing will have minimal benefits for individual consumers unless major breakthroughs are made in the near future.

Next

Generation Sequencing for personalized medicine

[Next-Generation Sequencing Leads To Personalized Medicine Win For Teenager](#)

Thursday, June 16, 2011 - 16:40 in [Biology & Nature](#)

Noah and Alexis Beery were diagnosed with cerebral palsy at age 2, but knowing that was only the first step on a journey to find an answer to the children's problems. Yet a determined mother determination and the high tech world of next-generation sequencing in the Baylor Human Genome Sequencing Center were able to solve the case. Writing in Science Translational Medicine, Baylor College of Medicine researchers, along with experts in San Diego and at the University of Michigan in Ann Arbor, describe how the sequencing of the children's whole genome along with that of their older brother and their parents zeroed in on the gene that caused the children's genetic disorder, which enabled physicians to fine-tune the treatment of their disorder....

(<http://esciencenews.com/sources/scientific.bloggng/2011/06/16/next.generation.sequencing.leads.to.personalized.medicine.win.for.teenager>)

Genetic epidemiology and public health

Genetic Epidemiology 7

Genetic epidemiology and public health: hope, hype, and future prospects

George Davey Smith, Shah Ebrahim, Sarah Lewis, Anna L Hansell, Lyle J Palmer, Paul R Burton

Lancet 2005; 366: 1484–98

This is the seventh, and final, paper in a Series on genetic epidemiology.

Department of Social Medicine, University of Bristol, Canynge Hall, Whiteladies Road, Bristol BS8 2PR, UK

(Prof G Davey Smith FRCP,

Prof S Ebrahim FRCP,

S Lewis PhD); Department of Epidemiology, Imperial College, London, UK (A L Hansell MB);

Laboratory for Genetic Epidemiology, School of Population Health and Western Australian Institute for Medical

Research and Centre for Medical Research, University of Western Australia, Perth, Australia (Prof L J Palmer PhD);

and Department of Health Sciences and Genetics, University of Leicester, Leicester, UK

(Prof P R Burton MD)

Genetic epidemiology is a rapidly expanding research field, but the implications of findings from such studies for individual or population health are unclear. The use of molecular genetic screening currently has some legitimacy in certain monogenic conditions, but no established value with respect to common complex diseases. Personalised medical care based on molecular genetic testing is also as yet undeveloped for common diseases. Genetic epidemiology can contribute to establishing the causal nature of environmentally modifiable risk factors, through the application of mendelian randomisation approaches and thus contribute to appropriate preventive strategies. Technological and other advances will allow the potential of genetic epidemiology to be revealed over the next few years, and the establishment of large population-based resources for such studies (biobanks) should contribute to this endeavour.

The recent advances covered in this series have equipped genetic epidemiologists with powerful methods for studying the genetic architecture of complex diseases, but direct contributions to public health have been restricted so far. The major current focus is on attempts to use genetic variants to identify individuals who are at high risk of disease, coupled with appropriate management to reduce their risk.¹ The potential of pharmacogenomic studies to contribute to personalised medicine has also been widely heralded.^{2–4} Major contributions to either health care or public health are only just beginning to be made. More encouragingly, findings from association

thinking and appropriately designed studies are needed. In this article, we discuss the current and potential effects of the genomic revolution on public health science and mainstream epidemiology, especially in the context of the very large-scale population resources (Biobanks) that are being established internationally.

Genomic profiling in the prevention and treatment of common diseases

Since the launch of the human genome project the potential of increased genetic knowledge to improve human health has been widely championed.^{15–17} In a

“Recent” success stories of genetics and genetic epidemiology research

- Gene expression profiling to assess prognosis and guide therapy, e.g. breast cancer
- Genotyping for stratification of patients according to risk of disease, e.g. myocardial infarction
- Genotyping to elucidate drug response, e.g. antiepileptic agents
- Designing and implementing new drug therapies, e.g. imatinib for hypereosinophilic syndrome
- Functional understanding of disease causing genes, e.g. obesity

(Guttmacher & Collins, N Engl J Med, 2003)

2.b Designs in genetic epidemiology

The samples needed for genetic epidemiology studies may be

- nuclear families (index case and parents),
- affected relative pairs (sibs, cousins, any two members of the family),
- extended pedigrees,
- twins (monozygotic and dizygotic) or
- unrelated population samples.

2.c Study types in genetic epidemiology

Main methods in genetic epidemiology

- **Genetic risk studies:**

- What is the contribution of genetics as opposed to environment to the trait? Requires family-based, twin/adoption or migrant studies.

- **Segregation analyses:**

- What does the genetic component look like (*oligogenic* 'few genes each with a moderate effect', *polygenic* 'many genes each with a small effect', etc)?
- What is the model of transmission of the genetic trait? Segregation analysis requires multigeneration family trees preferably with more than one affected member.

- **Linkage studies:**

- What is the location of the disease gene(s)? Linkage studies screen the whole genome and use parametric or nonparametric methods such as allele sharing methods {affected sibling-pairs method} with no assumptions on the mode of inheritance, penetrance or disease allele frequency (the parameters). The underlying principle of linkage studies is the cosegregation of two genes (one of which is the disease locus).

- **Association studies:**

- What is the allele associated with the disease susceptibility? The principle is the coexistence of the same marker on the same chromosome in affected individuals (due to linkage disequilibrium). Association studies may be family-based (TDT) or population-based. Alleles or haplotypes may be used. Genome-wide association studies (GWAS) are increasing in popularity.

3 Familial aggregation of a phenotype

Main references:

- Burton P, Tobin M and Hopper J. Key concepts in genetic epidemiology. *The Lancet*, 2005
- Thomas D. Statistical methods in genetic epidemiology. Oxford University Press 2004
- Laird N and Cuenco KT. Regression methods for assessing familial aggregation of disease. *Stats in Med* 2003

- Clayton D. Introduction to genetics (course slides Bristol 2003)
- URL:
 - <http://www.dorak.info/>

3.a Introduction to familial aggregation

What is familial aggregations?

- Consensus on a precise definition of familial aggregation is lacking
- The heuristic interpretation is that aggregation exists when cases of disease appear in families more often than one would expect if diseased cases were spread uniformly and randomly over individuals.
- The assessment of familial aggregation of disease is often regarded as the initial step in determining whether or not there is a genetic basis for disease.
- Absence of any evidence for familial aggregation casts strong doubt on a genetic component influencing disease, especially when environmental factors are included in the analysis.

What is familial aggregation? (continued)

- Actual approaches for detecting aggregation depend on the nature of the phenotype, but the common factor in existing approaches is that they are taken without any specific genetic model in mind.
- The basic design of familial aggregation studies typically involves sampling families
- In most places there is no natural sampling frame for families, so individuals are selected in some way and then their family members are identified. The individual who caused the family to be identified is called the *proband*.

Key question: does the phenotype run in families?

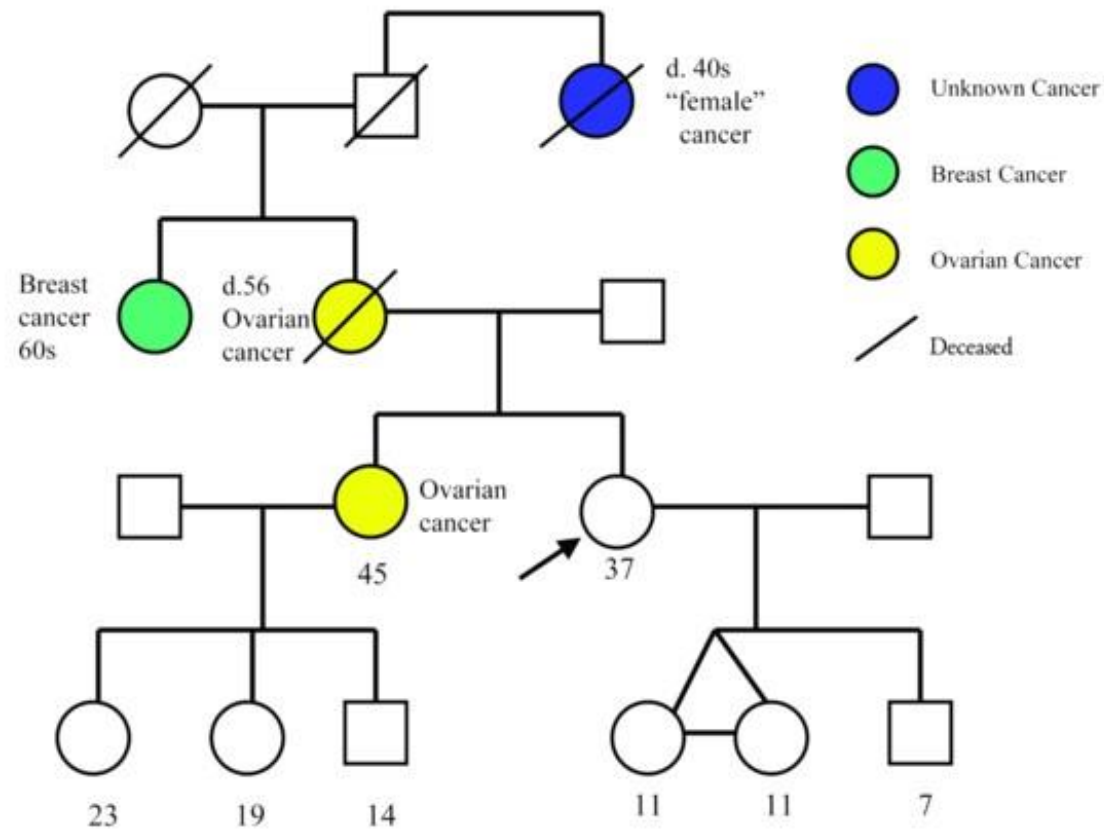

Define the phenotype !!!

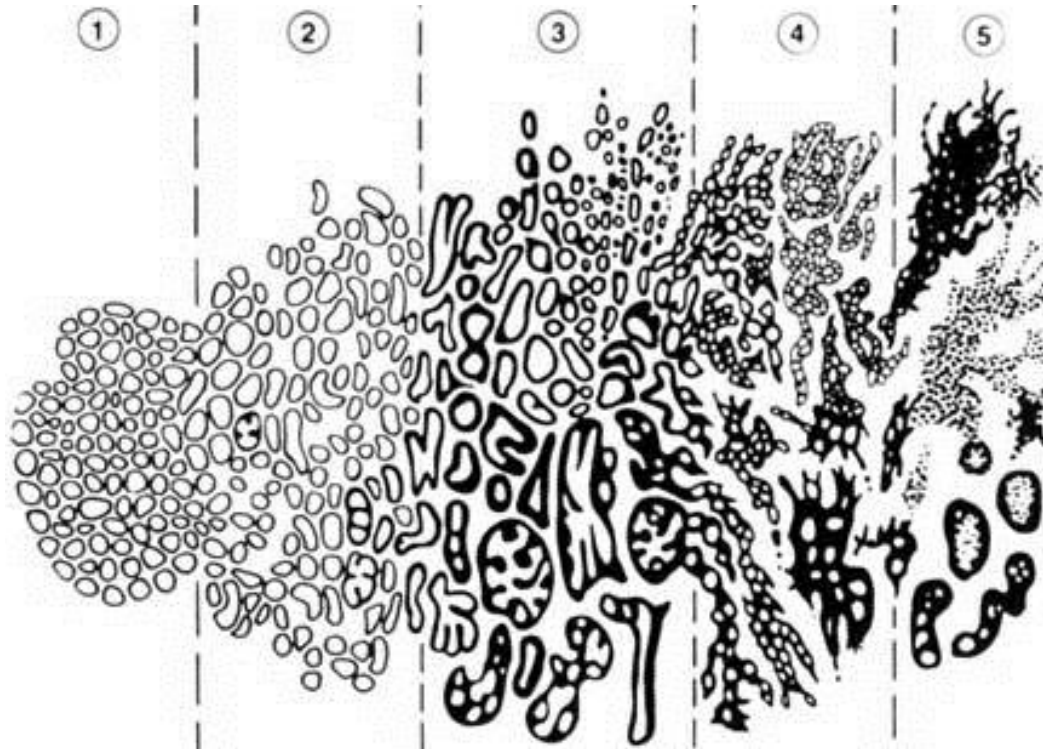

Gleason DF. In Urologic Pathology: The Prostate. 1977; 171-198

3.b Familial aggregation with quantitative traits

Proband selection

- For a continuous trait a random series of probands from the general population may be enrolled, together with their family members.

Correlations between trait values among family members

- For quantitative traits, such as blood pressure, familial aggregation can be assessed using a correlation or covariance-based measure
- For instance, the so-called *intra-family correlation coefficient* (ICC)
 - It describes how strongly units in the same group resemble each other
 - ICC can be interpreted as the proportion of the total variability in a phenotype that can reasonably be attributed to real variability between families
 - Techniques such as linear regression and multilevel modelling analysis of variance are useful to derive estimates
 - Non-random ascertainment can seriously bias an ICC.
- Alternatively, *familial correlation coefficients* are computed as in the programme FCOR within the Statistical Analysis for Genetic Epidemiology (SAGE) software package

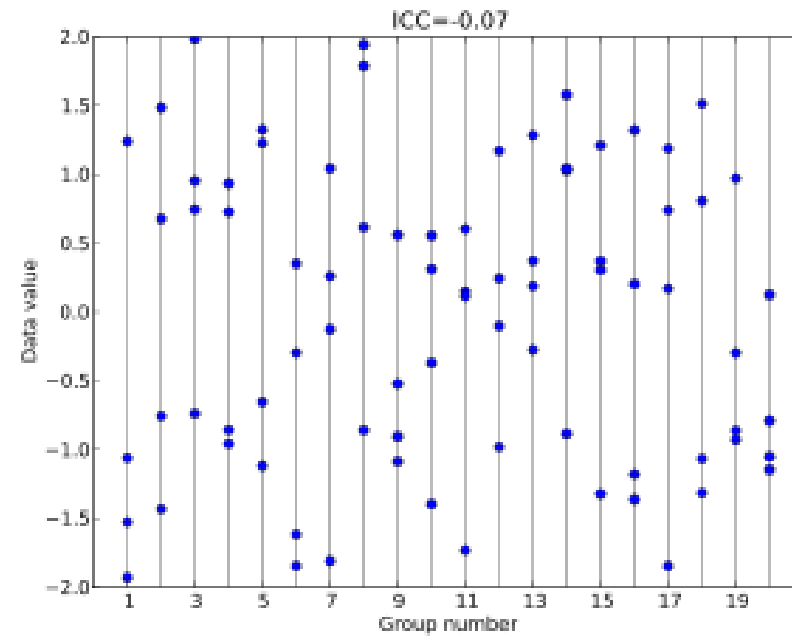
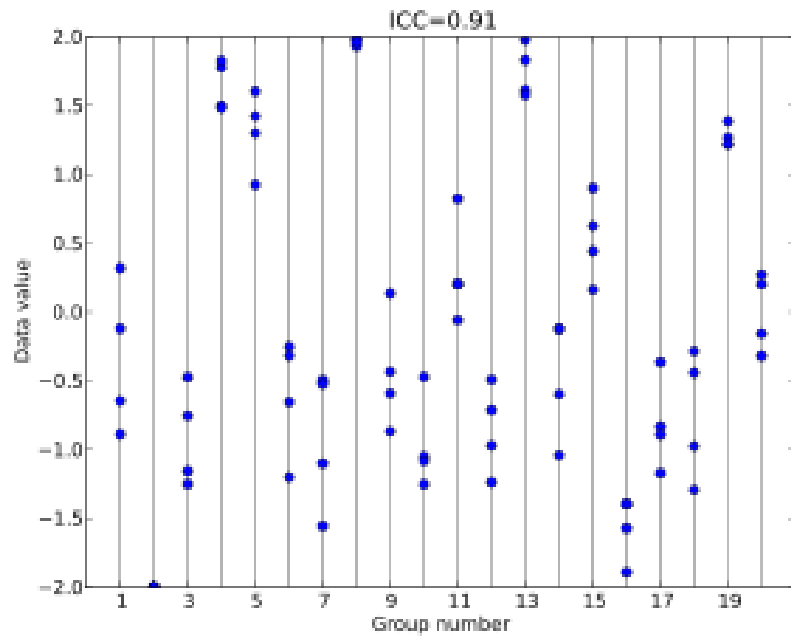

(http://en.wikipedia.org/wiki/Intraclass_correlation)

3.c Familial aggregation with dichotomous traits

Proband selection

- It is a misconception that probands always need to have the disease of interest.
- In general, the sampling procedure based on proband selection closely resembles the case-control sampling design, for which exposure is assessed by obtaining data on disease status of relatives, usually first-degree relatives, of the probands. This selection procedure is particularly practical when disease is relatively rare.

Two main streams in analysis

- In a retrospective type of analysis, the outcome of interest is disease in the proband. Disease in the relatives serves to define the exposure.
- Recent literature focuses on a prospective type of analysis, in which disease status of the relatives is considered the outcome of interest and is conditioned on disease status in the proband.

Recurrence risks

- One parameter often used in the genetics literature to indicate the strength of a gene effect is the familial risk ratio λ_R , where

$$\lambda_R = \lambda / K,$$

K the disease prevalence in the population and λ the probability that an individual has disease, given that a relative also has the disease.

- The risk in relatives of type R of diseased *probands* is termed relative *recurrence risk* λ_R and is usually expressed versus the population risk as above.
- We can use Fisher's (1918) results to predict the relationship between recurrence risk and relationship to affected probands, by considering a trait coded $Y = 0$ for healthy and $Y = 1$ for disease.

Then,

$$\text{Population mean}(Y) = \text{Prob}(Y = 1) = \text{Population risk, } K$$

Recurrence risks (continued)

- An alternative algebraic expression for the covariance is

$$\text{Covariance}(Y_1, Y_2) = \text{Mean}(Y_1 Y_2) - \text{Mean}(Y_1) \text{Mean}(Y_2)$$

with $\text{Mean}(Y_1 Y_2)$ the probability that both relatives are affected. From this we derive for the familial risk ratio λ , defined before:

$$\frac{\text{Prob}(Y_2 = 1 | Y_1 = 1)}{K} = \frac{\text{Prob}(Y_1 = 1 \ \& \ Y_2 = 1)}{K^2} = 1 + \frac{\text{Covariance}(Y_1, Y_2)}{K^2}$$

- It is intuitively clear (and it can be shown formally) that the covariance between Y_1 and Y_2 depends on the type of relationship (the so-called *kinship coefficient* ϕ (see later))
 - Regression methods may be used for assessing familial aggregation of diseases, using logit link functions

Kinship coefficients

- Consider the familial configuration

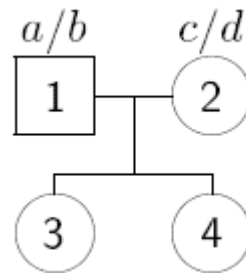

and suppose that the first sib (3) inherits the a and c allele.

- Then if **2-IBD** refers to the probability that the second sib (4) inherits a and c, it is $1/4 = 1/2 \times 1/2$
- If **1-IBD** refers to the probability that the second sib inherits a/d or b/c, it is $1/2 = 1/4 + 1/4$
- If **0-IBD** refers to the probability that the second sib inherits b and d, it is $1/4$

Kinship coefficients (continued)

- We denote this by:

$$z_0 = \frac{1}{4}, \quad z_1 = \frac{1}{2}, \quad z_2 = \frac{1}{4}$$

- F.i.: z_0 = probability that none of the two alleles in the second relative are *identical by descent* (IBD), at the locus of interest, and conditional on the genetic make-up of the first relative
- Now, consider an allele at a given locus picked at random, one from each of two relatives. Then the *kinship coefficient* ϕ is defined as the probability that these two alleles are IBD.

Kinship coefficients (continued)

- Given there is no inbreeding (there are no loops in the pedigree graphical representation),
 - Under 2-IBD, prob = $\frac{1}{2}$
 - Under 1-IBD, prob = $\frac{1}{4}$
 - Under 0-IBD, prob = 0
- So the kinship coefficient

$$\Phi = \frac{1}{2}z_2 + \frac{1}{4}z_1,$$

which is exactly half the average proportion of alleles shared IBD.

- The average proportion of alleles shared IBD = $(2 \times z_2 + 1 \times z_1)/2$

IBD sharing and kinship by relationship

Relationship	No. alleles shared IBD			Φ
	2	1	0	
	z_2	z_1	z_0	
Self, MZ twins	1	0	0	1/2
Parent–Offspring	0	1	0	1/4
Full siblings	1/4	1/2	1/4	1/4
Half siblings	0	1/2	1/2	1/8
Uncle–nephew	0	1/2	1/2	1/8
Double 1st cousins	1/16	6/16	9/16	1/8
Grandchild–grandparent	0	1/4	3/4	1/16
First cousins	0	1/4	3/4	1/16
Second cousins	0	1/16	15/16	1/64

(assuming no inbreeding)

Interpretation of values of relative recurrence risk

- Examples for λ_S = ratio of risk in sibs compared with population risk.
 - cystic fibrosis: the risk in sibs = 0.25 and the risk in the population = 0.0004, and therefore $\lambda_S = 500$
 - Huntington disease: the risk in sibs = 0.5 and the risk in the population = 0.0001, and therefore $\lambda_S = 5000$
- Higher value indicates greater proportion of risk in family compared with population.
- The relative recurrence risk increases with
 - Increasing genetic contribution
 - Decreasing population prevalence

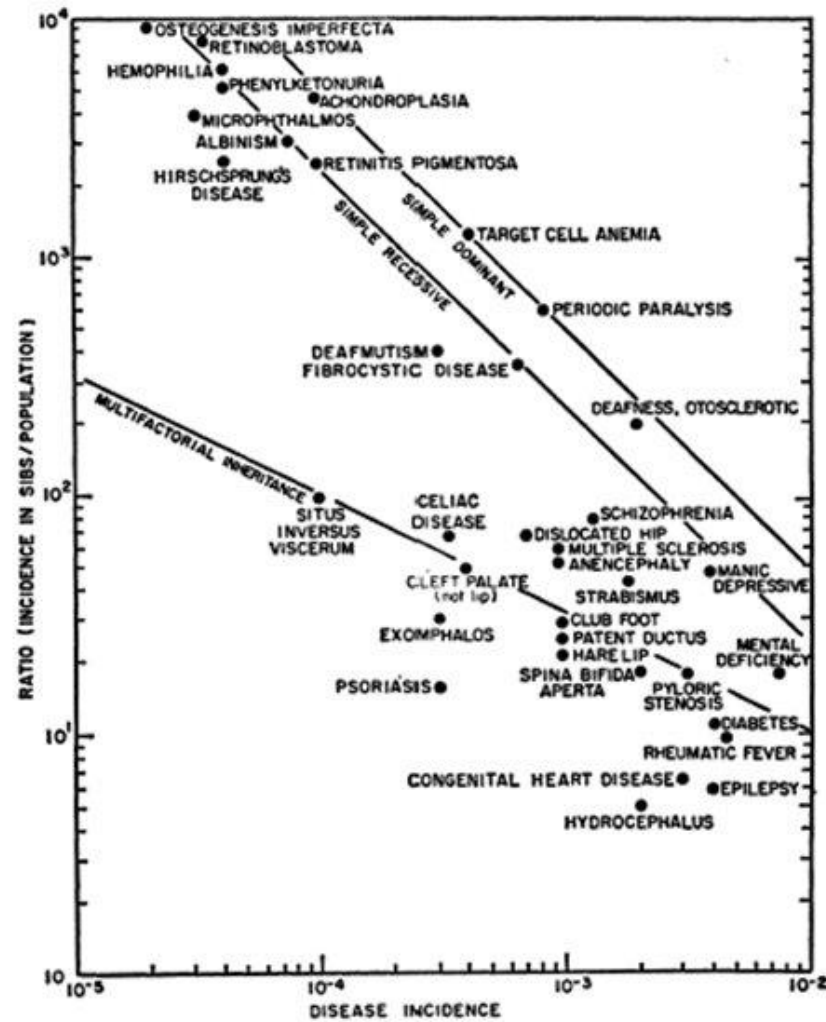

Relation between disease incidence and relative incidence in sibs of affected individuals for a number of diseases. The lines indicate the expected relationships for simple dominant, simple recessive and Edwards' (1963) approximation to multifactorial inheritance (from Newcombe, 1964).

Interpretation of values of relative recurrence risk (continued)

- The presence of familial aggregation can be due to many factors, including shared family environment.
- Hence, familial aggregation alone is not sufficient to demonstrate a genetic basis for the disease.
- Here, variance components modeling may come into play to explain the *pattern of familial aggregation* and to derive estimates of *heritability* (see next section: segregation analysis)
- When trying to decipher the importance of genetic versus environmental factors, twin designs are extremely useful:

3. e Twin studies

Environment versus genetics

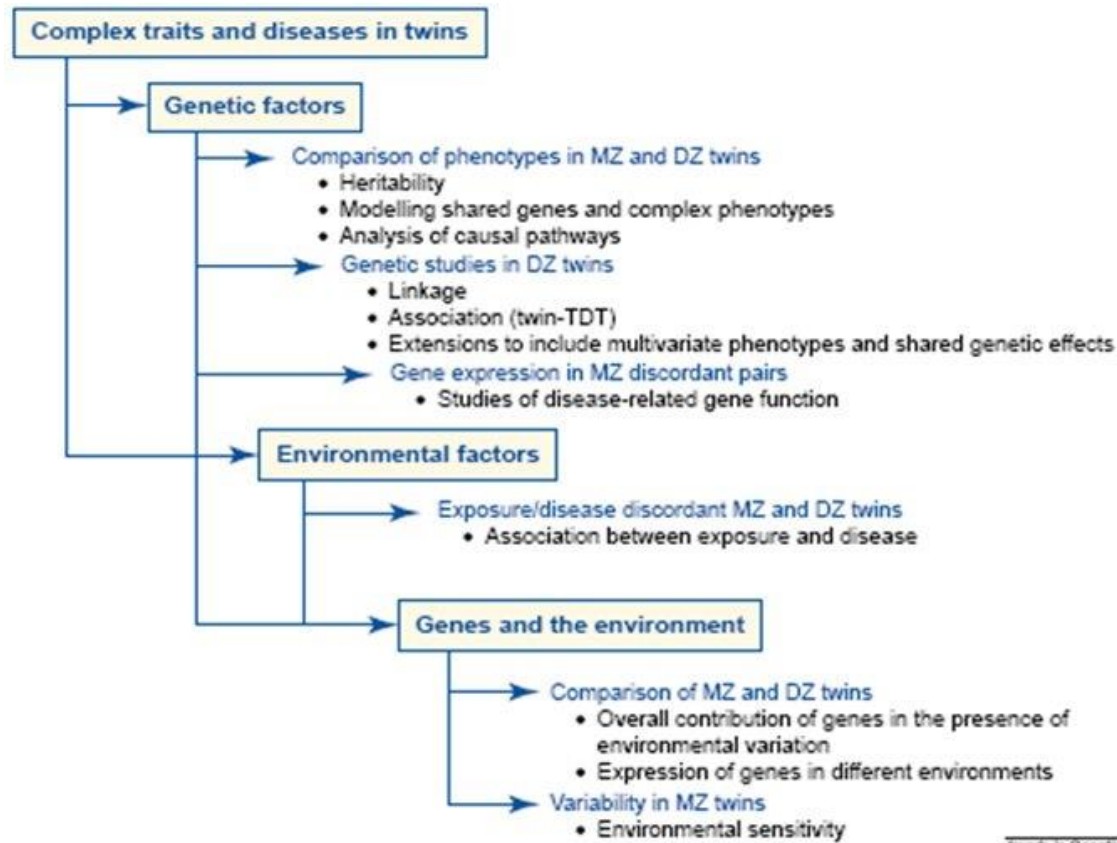

Trends in Genetics

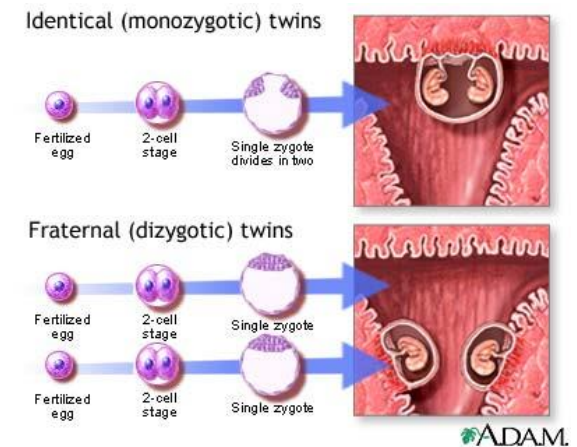

Contribution of twins to the study of complex traits and diseases

- *Concordance* is defined as is the probability that a pair of individuals will both have a certain characteristic, given that one of the pair has the characteristic.
 - For example, twins are concordant when both have or both lack a given trait
- One can distinguish between pairwise concordance and proband wise concordance:
 - *Pairwise concordance* is defined as $C/(C+D)$, where C is the number of concordant pairs and D is the number of discordant pairs
 - For example, a group of 10 twins have been pre-selected to have one affected member (of the pair). During the course of the study four other previously non-affected members become affected, giving a pairwise concordance of $4/(4+6)$ or $4/10$ or 40%.

Contribution of twins to the study of complex traits and diseases

(continued)

- *Proband wise concordance* is the proportion $(2C_1+C_2)/(2C_1+C_2+D)$, in which $C = C_1+C_2$ and C is the number of concordant pairs, C_2 is the number of concordant pairs in which one and only one member was ascertained and D is the number of discordant pairs.

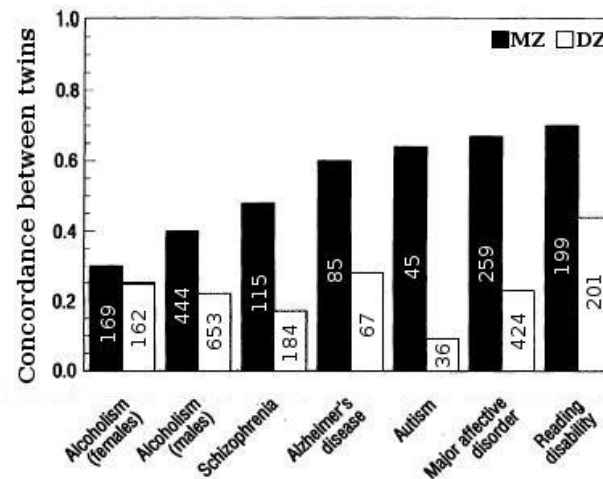

(<http://en.wikipedia.org/wiki/File:Twin-concordances.jpg>)

Some details about twin studies

- The basic logic of the twin study can be understood with very little mathematics beyond an understanding of correlation and the concept of variance.
- Classic twin studies begin from assessing the variance of trait in a large group / attempting to estimate how much of this is due to genetic variance (*heritability*), how much appears to be due to shared environmental effects, and how much is due to unique environm. effects (i.e., events

occurring to one twin but not another).

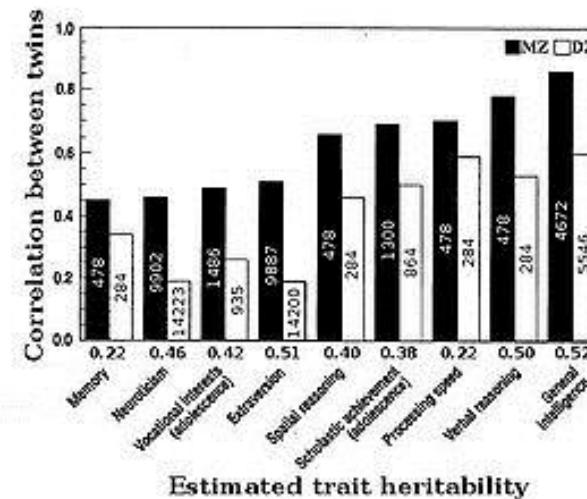

(<http://en.wikipedia.org/wiki/File:Heritability-from-twin-correlations1.jpg>)

Some details about twin studies (continued)

- Identical twins (MZ twins) are twice as genetically similar as DZ twins. Yet 2 individuals may be exposed to shared or unshared environmental (including measurement error) effects.

Heritability Based on Twin Data			
Heritability estimates the contribution of genetic elements to the phenotype.			
	MZ twin	DZ twin	Heritability
High Blood Pressure	0.6 - 0.8	0.3 - 0.5	0.60
Asthma	0.12 - 0.89	0 - 0.5	0.72 - 0.8
Type 1 Diabetes	0.25 - 0.35	0.03 - 0.05	0.72
Type 2 Diabetes	0.50	0.37	0.26
Rheumatoid Arthritis	0.15	0.04	0.32

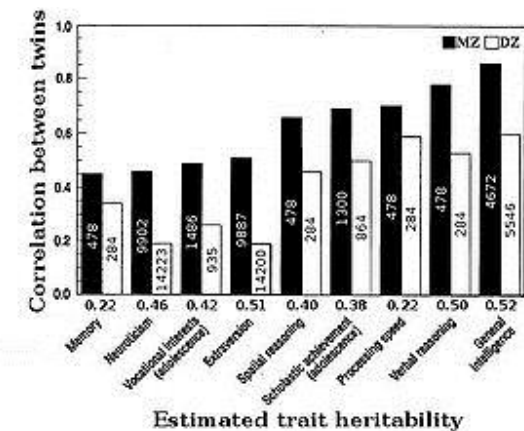

- Unique environmental variance (e^2 or E) is reflected by the degree to which identical twins raised together are dissimilar, and is approximated by $1 - \text{MZ correlation}$.
- The effect of shared environment (c^2 or C) contributes to similarity in all cases (MZ, DZ) and is approximated by $\text{MZ correlation} - \text{estimated heritability}$

Some details about twin studies (continued)

- How to estimate heritability?
 - Given the ACE model, researchers can determine what proportion of variance in a trait is heritable, versus the proportions which are due to shared environment or unshared environment, for instance using programs that implement structural equation models (SEM) - e.g., available in the freeware Mx software .
 - The A in the ACE model stands for the additive genetic effect size (cfr. additive genetic variance, narrow heritability). It is also possible to examine non-additive genetics effects (often denoted D for dominance (*ADE model*)).
- Consequently, heritability (h^2) is approximately twice the difference between MZ and DZ twin correlations.

Some details about twin studies (continued)

- *Monozygous (MZ) twins* raised in a family share both 100% of their genes, and all of the shared environment (actually, this is often just an assumption). Any differences arising between them in these circumstances are random (unique).
 - The correlation we observe between MZ twins therefore provides an estimate of $A + C$.
- *Dizygous (DZ) twins* have a common shared environment, and share on average 50% of their genes.
 - So the correlation between DZ twins is a direct estimate of $\frac{1}{2}A + C$.

Different studies may lead to quite different heritability estimates!



(Maher 2008)

4 Segregation analysis

Main references:

- Burton P, Tobin M and Hopper J. Key concepts in genetic epidemiology. *The Lancet*, 2005
- Thomas D. Statistical methods in genetic epidemiology. Oxford University Press 2004
- Clayton D. Introduction to genetics (course slides Bristol 2003)
- URL:
 - <http://www.dorak.info/>

Additional reading:

- Ginsburg E and Livshits G. Segregation analysis of quantitative traits, *Annals of human biology*, 1999

4.a What is a segregation analysis?

Harry Potter's pedigree

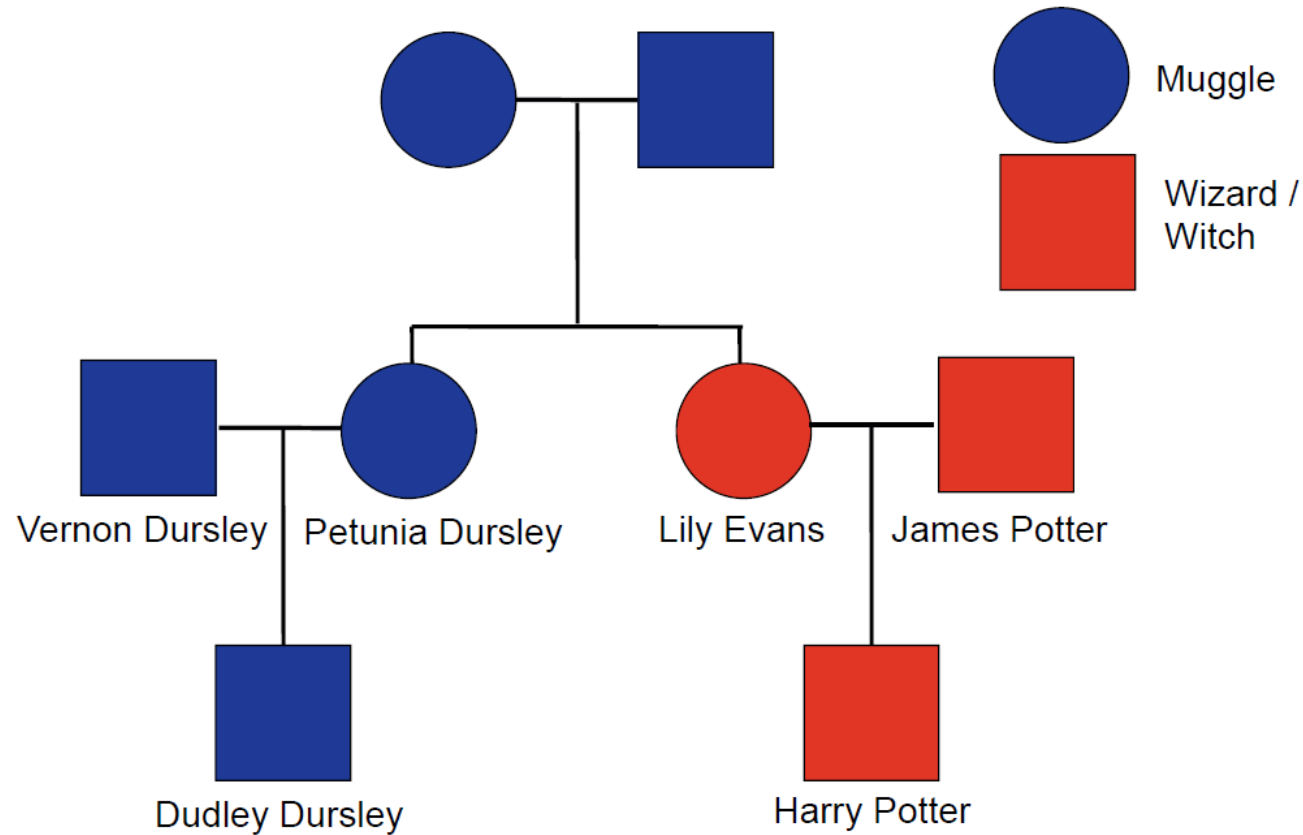

Definition of segregation analysis

- Segregation analysis is a statistical technique that attempts to explain the causes of family aggregation of disease.
- It aims to determine the *transmission pattern of the trait* within families and to test this pattern against predictions from specific genetic models:
 - Dominant? Recessive? Co-dominant? Additive?
- Segregation analysis entails fitting a variety of models (both genetic and non-genetic; major genes or multiple genes/polygenes) to the data obtained from families and evaluating the results to determine which model best fits the data.
- As in aggregation studies, families are often ascertained through probands
- This information is useful in parametric linkage analysis, which assumes a defined model of inheritance

Affected sib-pair linkage

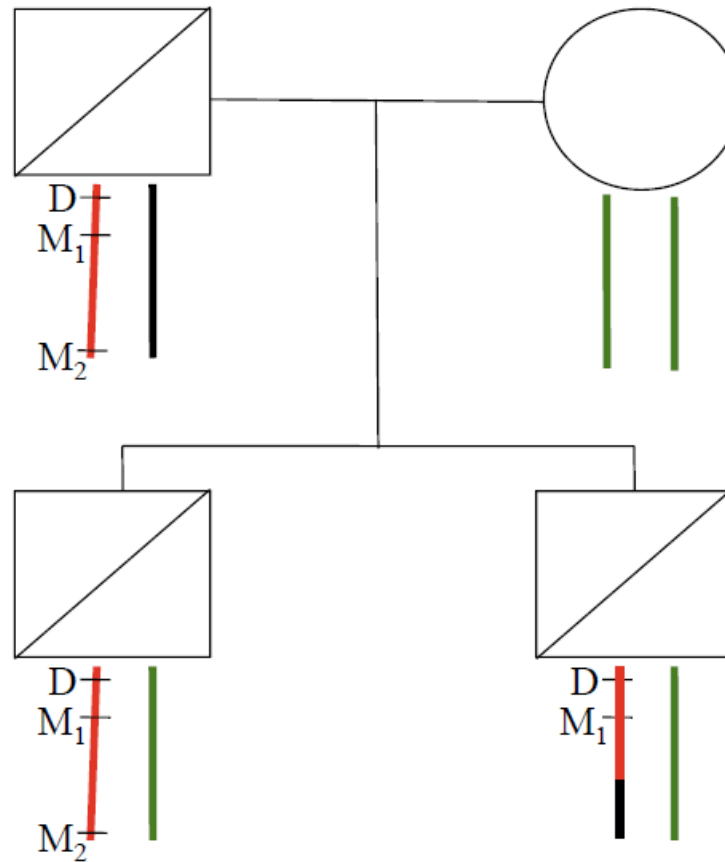

Modes of inheritance

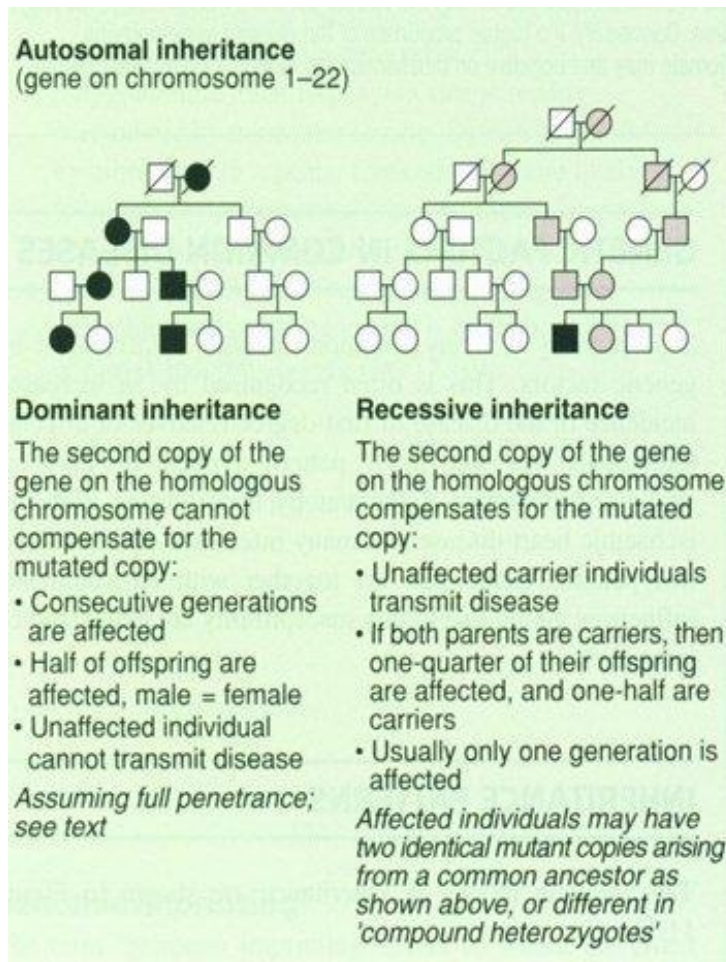

Left: single gene and Mendelian inheritance

Increasing levels of complexity:

- Single gene and non-Mendelian (e.g., mitochondrial DNA)
- Multiple genes (e.g., polygenic, oligogenic)

(See also Roche Genetics)

Mitochondrial DNA

- Mitochondrial DNA (mtDNA) is the DNA located in the mitochondria, structures within eukaryotic cells that convert the chemical energy from food into a form that cells can use, adenosine triphosphate (ATP). Most of the rest of human DNA present in eukaryotic cells can be found in the cell nucleus. In most species, including humans, mtDNA is inherited solely from the mother (i.e., maternally inherited).
- In humans, mitochondrial DNA can be regarded as the smallest chromosome coding for only 37 genes and containing only about 16,600 base pairs.
- Human mitochondrial DNA was the first significant part of the human genome to be sequenced.

Distinguishing between different types of genetic diseases

- **Monogenic diseases** are those in which defects in a single gene produce disease. Often these disease are severe and appear early in life, e.g., cystic fibrosis. For the population as a whole, they are relatively rare. In a sense, these are pure genetic diseases: They do not require any environmental factors to elicit them. Although nutrition is not involved in the causation of monogenic diseases, these diseases can have implications for nutrition. They reveal the effects of particular proteins or enzymes that also are influenced by nutritional factors

(<http://www.utsouthwestern.edu>)

- **Oligogenic diseases** are conditions produced by the combination of two, three, or four defective genes. Often a defect in one gene is not enough to elicit a full-blown disease; but when it occurs in the presence of other moderate defects, a disease becomes clinically manifest. It is the expectation of human geneticists that many chronic diseases can be explained by the combination of defects in a few (major) genes.
- A third category of genetic disorder is **polygenic disease**. According to the polygenic hypothesis, many mild defects in genes conspire to produce some chronic diseases. To date the full genetic basis of polygenic diseases has not been worked out; multiple interacting defects are highly complex!!!

(<http://www.utsouthwestern.edu>)

- **Complex diseases** refer to conditions caused by many contributing factors. Such a disease is also called a multifactorial disease.
 - Some disorders, such as sickle cell anemia and cystic fibrosis, are caused by mutations in a single gene.
 - Common medical problems such as heart disease, diabetes, and obesity likely associated with the effects of multiple genes in combination with lifestyle and environmental factors, all of them possibly interacting.

Two terms frequently used in a segregation analysis

- So the aim of segregation analysis is to find evidence for the existence of a major gene for the phenotype under investigation and to estimate the corresponding mode of inheritance, or to reject this assumption
- The *segregation ratios* are the predictable proportions of genotypes and phenotypes in the offspring of particular parental crosses. e.g. 1 AA : 2 AB : 1 BB following a cross of AB X AB
- *Segregation ratio distortion* is a departure from expected segregation ratios. The purpose of segregation analysis is to detect significant segregation ratio distortion. A significant departure would suggest one of our assumptions about the model wrong.

4.b Classical method for sibships and one locus

Steps of a simple segregation analysis

- Identify mating type(s) where the trait is expected to segregate in the offspring.
- Sample families with the given mating type from the population.
- Sample and score the children of sampled families.
- Estimate segregation ratio or test H_0 : “expected segregation ratio” (e.g., hypothesizing a particular mode of inheritance) .

Example: Autosomal dominant

Data and hypothesis:

- Obtain a random sample of matings between affected (Dd) and unaffected (dd) individuals.
- Sample n of their offspring and find that r are affected with the disease (i.e. Dd).
- H_0 : proportion of affected offspring is 0.5

Testing:

- Binomial test

4.c Likelihood method for pedigrees and one locus

Segregation analysis in practice

- For more complicated structures, segregation models are generally fitted using the method
- of maximum likelihood. In particular, the parameters of the model are fitted by finding the values that maximize the probability (*likelihood*) of the observed data.
- The essential elements of (this often complex likelihood) are
 - the penetrance function (i.e., $\text{Prob}(\text{Disease} \mid \text{Genotype})$)
 - the population genotype
 - the transmission probabilities within families
 - the method of ascertainment

Segregation analysis involves computing (often very complicated!) probabilities

- For extended pedigrees with many individuals and several generations a numerical procedure is needed for all probability calculations.
- Let L denote the likelihood for the observed phenotypes Y , given a genetic model M and the pedigree structure. L can be calculated by summing over all possible genotypic constellations $g_i, i = 1, \dots, N$, where N denotes the number of individuals in the pedigree:

$$L(Y) = \sum_{g_1} \sum_{g_2} \cdots \sum_{g_N} P(Y|g_1 g_2 \cdots g_N) P(g_1 g_2 \cdots g_N) .$$

- It is assumed that the phenotype of an individual is independent of the other pedigree members given its genotype.
- Widely used in segregation analysis is the **Elston–Stuart** algorithm (Elston and Stuart 1971), a recursive formula for the computation of the likelihood L given as

$$L = \sum_{g_1} \sum_{g_2} \cdots \sum_{g_N} \prod_{j=1}^N f(g_j) \prod_{k=1}^{N_1} P(g_k) \prod_{m=1}^{N_2} \tau(g_m | g_{m1} g_{m2}) .$$

(Bickeböller – Genetic Epidemiology)

- The Elston-Stewart peeling algorithm involves starting at the bottom of a pedigree and computing the probability of the parent's genotypes, given their phenotypes and the offspring's phenotypes, and working up from there, at each stage using the genotype probabilities that have been computed at lower levels of the pedigree

The notation for the formula is as follows: N denotes the number of individuals in the pedigree. N_1 denotes the number of *founder* individuals in the pedigree. Founders are individuals without specified parents in the pedigree. In general, these are the members of the oldest generation and married-in spouses. N_2 denotes the number of *non-founder* individuals in the pedigree, such that $N = N_1 + N_2$. $g_i, i = 1, \dots, N$, denote the genotype of the i th individual of the pedigree.

The parameters of the genetic model M fall into three groups: (1) The genotype distribution $P(g_k), k = 1, \dots, N_1$, for the founders is determined by population parameters and often Hardy–Weinberg equilibrium is assumed. (2) The transmission probabilities for the transmission from parents to offspring $\tau(g_m | g_{m1}, g_{m2})$, where $m1$ and $m2$ are the parents of m , are needed for all non-founders in the pedigree. It is assumed that transmissions to different offspring are independent given the parental genotypes and that transmissions of one parent to an offspring are independent of the transmission of the other parent. Thus, transmission probabilities can be parametrized by the product of the individual transmissions. Under Mendelian segregation the transmission probabilities for parental transmission are $\tau(S_1 | S_1 S_1) = 1; \tau(S_1 | S_1 S_2) = 0.5$ and $\tau(S_1 | S_2 S_2) = 0$. (3) The penetrances $f(g_i), i = 1, \dots, N$, parametrize the genotype-phenotype correlation for each individual i .

4.d Variance component modeling; a general framework

Introduction

- The extent to which any identified familial aggregation is caused by genes, can be estimated by a biologically rational model that specifies how precisely a trait is modulated by the effect of one or more genes.
- One of the most common such models is the additive model:
 - a given allele at a given locus adds a constant to, or subtracts a constant from, the expected value of the trait
- Here, no information about genotypes or measured environmental determinants is required! Hence, no blood needs to be taken for DNA analysis.

(Burton et al, The Lancet, 2005)

Dissecting the genetic variance

- In an “analysis of variance” framework:

- The additive component of variance is the variance explained by a model in which maternal and paternal alleles have simple additive effects on the mean trait value.
- The dominance component represents residual genetic variance not explained by a simple sum of effects

- In 1918, Fisher established the relationship between the covariance in trait values between two relatives and their relatedness
- The resulting correlation matrix can be analyzed by variance components or path analysis techniques to estimate the proportion of variance due to shared environmental and genetic influences.

Example: a bi-allelic locus

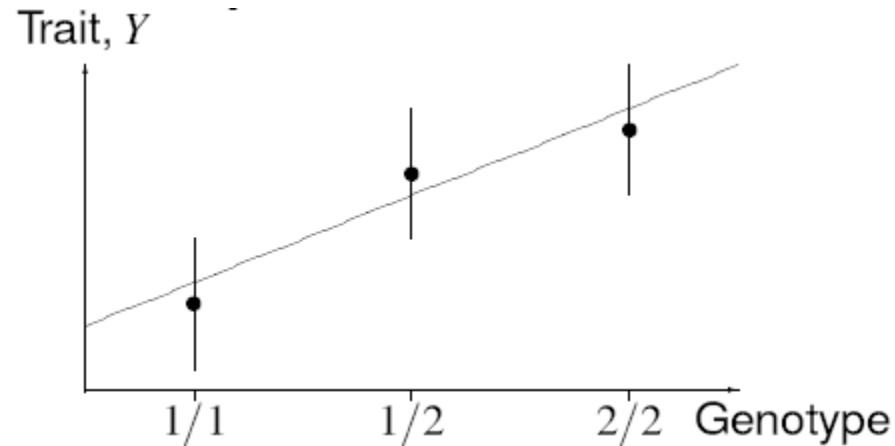

- Environment variance is represented by the vertical bars
- Total genetic variance is variance between genotype means (●)
 - Additive component is that *due to* the regression line,
 - Dominance component is that *about* the regression line

Trait covariances and IBD (no shared environmental influences)

- Two individuals who share **2 alleles IBD** at the trait locus are genetically identical in so far as that trait is concerned. The covariance between their trait values is the total genetic variance

$$\sigma_{\text{Gen}}^2 = \sigma_{\text{Add}}^2 + \sigma_{\text{Dom}}^2$$

- Two individuals who share **1 allele IBD** at the trait locus share the genetic effect of that allele. The covariance between their trait values is half the additive component of variance,

$$\sigma_{\text{Add}}^2/2$$

- Two individuals who share **0 alleles IBD** at the trait locus are effectively unrelated. The covariance between their trait values is zero

IBD sharing, kinship and trait correlation

- Therefore, the covariance between trait values in two relatives is

$$z_1 \frac{\sigma_{\text{Add}}^2}{2} + z_2 (\sigma_{\text{Add}}^2 + \sigma_{\text{Dom}}^2) = 2\Phi \sigma_{\text{Add}}^2 + z_2 \sigma_{\text{Dom}}^2$$

$$\Phi = \frac{1}{2}z_2 + \frac{1}{4}z_1,$$

- The dominance component is frequently (assumed to be) small so that covariance is proportional to the kinship coefficient

Single major locus

- If inheritance of the trait were due to a single major locus, the bivariate distribution for two relatives would be a mixture of circular clouds of points
 - Spacing of cloud centres depends on additive and dominance effects
 - Marginal distributions depend on allele frequency
- Tendency to fall along diagonals depends on IBD status (hence on relationship)

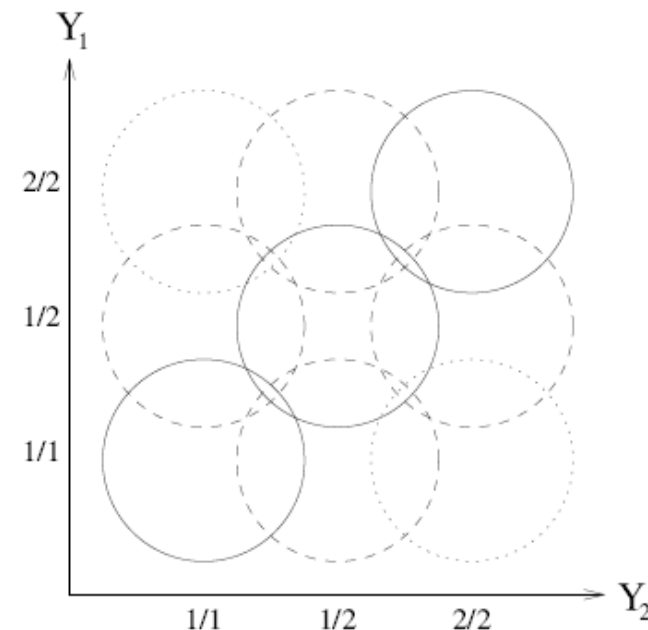

Polygenic model

- In the model for polygenic inheritance, the trait is determined by the sum of very many small effects of different genes
- The distribution of the trait in two relatives, Y_1 and Y_2 , is *bivariate normal* . an elliptical cloud of points

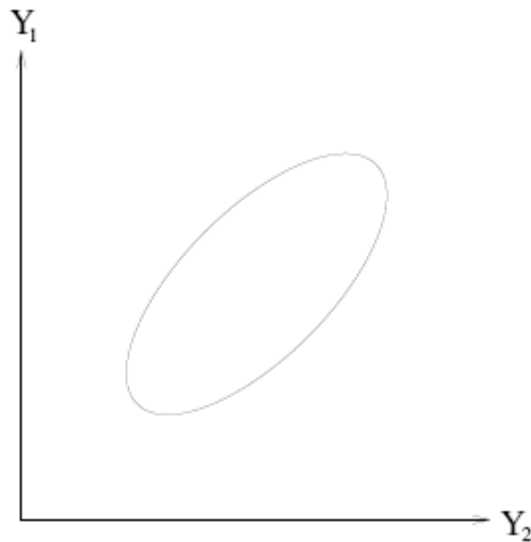

- Correlation is determined by
- Degree of relationship (IBD probabilities)
 - Heritability

The Morton-Maclean model (the “mixed model”)

- In this model, the trait is determined by additive effects of a single major locus plus a polygenic component. The bivariate distribution for two relatives is now a mixture of elliptical clouds:

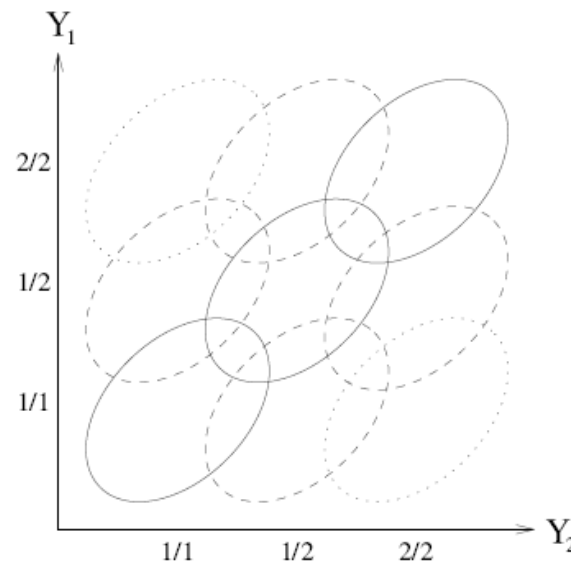

- The regressive model provides a convenient approximation to the “mixed model” in genetics.

The Morton-Maclean model (continued)

- In this model it is necessary to allow for the manner in which pedigrees have been recruited into the study; Ascertained pedigrees in the study may be skewed, either deliberately or inadvertently, towards those with extreme trait values for one or more family members. This complicates the analyses even further...
- Segregation analyses were often over-interpreted: the results depend on very strong model assumptions:
 - additivity of effects (major gene, polygenes, and environment)
 - bivariate normality of distribution of trait given genotype at the major locus

Types of variance component modeling

- Variance components analysis can be undertaken with conventional techniques such as maximum likelihood or Markov chain Monte Carlo based approaches.
- Genetic epidemiologists use various approaches to aid the specification of such models, including path analysis, which was invented by Sewall Wright nearly 100 years ago and the fitting is achieved by various programs.
- Equivalent approaches can also be used for binary phenotypes (using liability threshold models) and for traits that can best be expressed as a survival time such as age at onset or age at death.

(Burton et al, The Lancet, 2005)

4.e The ideas of variance component modeling adjusted for binary traits

- Aggregation of discrete traits, such as diseases in families have been studied by an extension of the Morton-Maclean model
- Here a latent liability to disease is assumed that behaves as a quantitative trait, with a mixture of major gene and polygene effects. When liability exceeds a threshold, disease occurs
- As in the quantitative trait case, this approach relies upon (too?) strong modeling assumptions

4.f Quantifying the genetic importance in familial resemblance

Heritability

- Recall: One of the principal reasons for fitting a variance components model is to estimate the variance attributable to additive genetic effects
- This quantity represents that component of the total phenotypic variance, usually that can be attributed to unmeasured additive genetic effects. It leads to the concept of *narrow heritability*.
- In contrast, *broad heritability* is defined as the proportion of the total phenotypic variance that is attributable to all genetic effects, including non-additive effects at individual loci and between loci.

(Burton et al, The Lancet, 2005)